

SW-D

Weighing Indicator
For Super Washdown Scales

SET UP INSTRUCTIONS

AND
A&D Company, Limited

Warning Definition

The warning described in this manual has the following meaning:

| | |
|---|--|
|  DANGER | An imminently hazardous situation which, if not avoided, will result in death or serious injury. |
|---|--|

© 2011 A&D Company, Limited. All rights reserved.

No part of this publication may be reproduced, transmitted, transcribed, or translated into any language in any form by any means without the written permission of A&D Company, Limited.

The contents of this manual and the specifications of the instrument covered by this manual are subject to change for improvement without notice.

CONTENTS

| | |
|---|----|
| 1. COMPLIANCE | 2 |
| 2. INTRODUCTION | 3 |
| 3. FEATURES | 3 |
| 4. UNPACKING | 4 |
| 5. INSTALLATION and PRECAUTIONS | 5 |
| 5.1. Precautions for Installing the Indicator..... | 5 |
| 5.2. Connecting to the load cell | 5 |
| 5-3. Verifying Load Cell Output and Input Sensitivity..... | 6 |
| 5-4. Setting Up the Indicator..... | 7 |
| 5-5. Parameter Settings and Calibration | 7 |
| 6. DESCRIPTION OF EACH PART | 8 |
| 7. CALIBRATION | 10 |
| 7.1. Items of the calibration mode | 10 |
| 7.2. Setting of the weighing capacity / division / decimal point position | 12 |
| 7.3. Gravity acceleration correction | 13 |
| 7.4. Calibration using a weight | 14 |
| 8. SETTING FUNCTIONS OR UNITS FOR USE | 16 |
| 8.1. Setting of the CF function | 16 |
| 8.2. Setting unit for use | 17 |
| 8.3. CF Function list | 18 |
| 9. OPTIONS | 19 |
| 9.1. SW-11 Display stand / Wall-mount | 19 |
| 10. MAINTENANCE | 20 |
| 10.1. Notes on maintenance..... | 20 |
| 10.2. Error codes..... | 20 |
| 11. SPECIFICATIONS | 21 |
| 11.1. Specifications..... | 21 |
| 11.2. External dimensions | 22 |
| GRAVITY ACCELERATION MAP | 23 |

1. COMPLIANCE

Compliance with FCC rules

- Please note that this equipment generates, uses and can radiate radio frequency energy. This equipment has been tested and has been found to comply with the limits of a Class A computing device pursuant to Subpart J of Part 15 of FCC rules. These rules are designed to provide reasonable protection against interference when equipment is operated in a commercial environment. If this unit is operated in a residential area it might cause some interference and under these circumstances the user would be required to take, at his own expense, whatever measures are necessary to eliminate the interference.

(FCC = Federal Communications Commission in the U.S.A.)

Classification of protection provided by enclosures

- The equipment is designed to comply with the IP Code of IEC 60529.
The "IP69K" is explained as follows:

"IP" International Protection.

"6" Against ingress of solid foreign objects.
Dust-tight. No ingress of dust.

"9K" Against ingress of water with harmful effects.
High pressure water jets directed against the enclosure from any direction shall have no harmful effects. (DIN40050 Part 9)

2. INTRODUCTION

This manual describes how this product works and how to get the most out of it in terms of performance.

The SW-D weighing indicator may be used to build a water-proof digital scale to specification IP69K. It has similar specifications and functions as an indicator of the SW series.

Please refer to the instruction manual for the SW supplied with the SW-D.

3. FEATURES

The SW-D weighing indicator is an electronic display instrument used to build a water-proof scale to specification IP69K by the combination of the SW-D and a weighing unit (Load cell), with the following features:

- Dust-tight and water-tight construction, complying with IP69K.
- Employing touch-sensitive keys enabled the display to be covered with a plastic sheet, resulting in better dust-tight and water-tight performance.
When a key is touched, the corresponding LED, above that key, turns on to indicate that the key has been touched.
- A bright LED display, with a broad viewing angle.
- Operating up to four 350 Ω load cells is available.
- Available range selection, for the display resolution, is 1/20 to 1/60,000.
- Free setting of the weighing capacity, within the display resolution of 1/60,000, is available.
- Available weighing units are kg (kilogram), g (gram), lb (pound), oz (ounce), and pcs (pieces for the counting mode).
- The counting mode easily counts the number of objects of the same weight.
- The comparator mode compares the displayed value (weight value) with the previously set comparator values and indicates the results by the large and bright LED display. The optional comparator relay output (SW-03) can output the results as a relay signal.
- The auto-tare function, used with the comparator mode, automatically tares and displays "OK" for a certain amount of sample and repeats this process for the next weighing.
- Using the optional RS-232C serial interface (SW-03) or optional RS-422/485 serial interface (SW-04) provides serial data output of the weight value and relay output of the comparison result.
- The optional sealed lead acid (SLA) battery (HC-02i) can be installed, allowing the scale to be used where an AC power source is not available.
- SW-11 provides the function of a display stand or wall-mount bracket for the SW-D.

4. UNPACKING

Unpack the indicator carefully and keep the packing material if you are likely to transport the indicator again in the future.

When unpacking, check whether all of the following items are included:

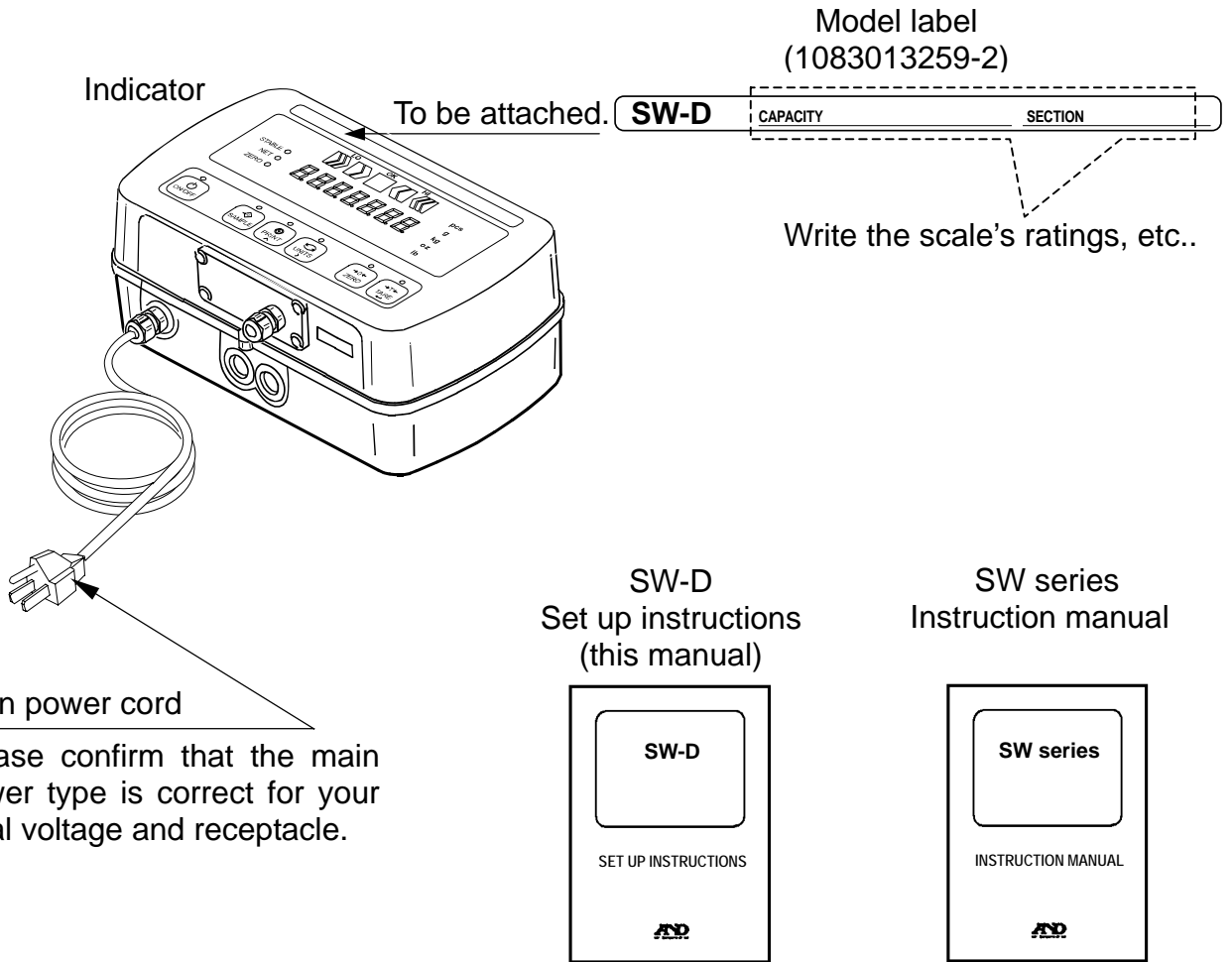

5. INSTALLATION and PRECAUTIONS

5.1. Precautions for Installing the Indicator

⚠ DANGER

- Ground the indicator so that the user will not be subjected an electric shock.
- Do not handle the main power cord with wet hands.
- The AC plug is not water-resistant. Install it in an area where it does not get wet.
- Even when the optional sealed lead acid (SLA) battery (HC-02i) is used, be sure to prevent the AC plug from getting wet.
- Do not install the indicator where there is flammable or corrosive gas present.
- Do not pull, fold or arrange cables forcibly.
- Use shielded cables for all connections.
- Ground the platform to be connected to the indicator to avoid a risk of electric shock.

Read the section “PRECAUTIONS” in the instruction manual of the SW to understand the conditions and precautions for installation, operation and cleaning the indicator.

5.2. Connecting to the load cell

1. Disconnect the main power cord of the scale from the power source.
2. On the bottom of the display, remove the screw protection caps on the load cell panel. Loosen the four screws and open the load cell panel.
3. Loosen the cable clamp locking nut on the load cell panel and insert the load cell cable through the cable clamp.

Accommodates load cell cable diameters of ϕ 3.5 to 7.0 mm.

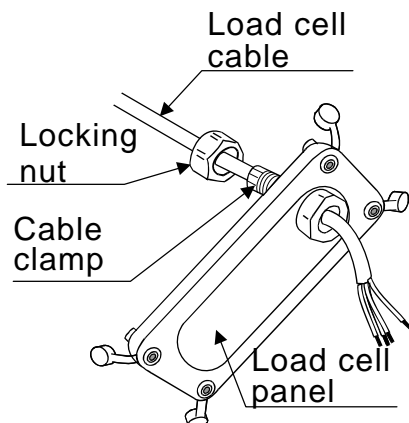

4. Solder the wires to the pin contacts of the connector.

- A 5 m or less load cell cable is recommended as the SW-D uses a 4 wire system (no remote sensing).

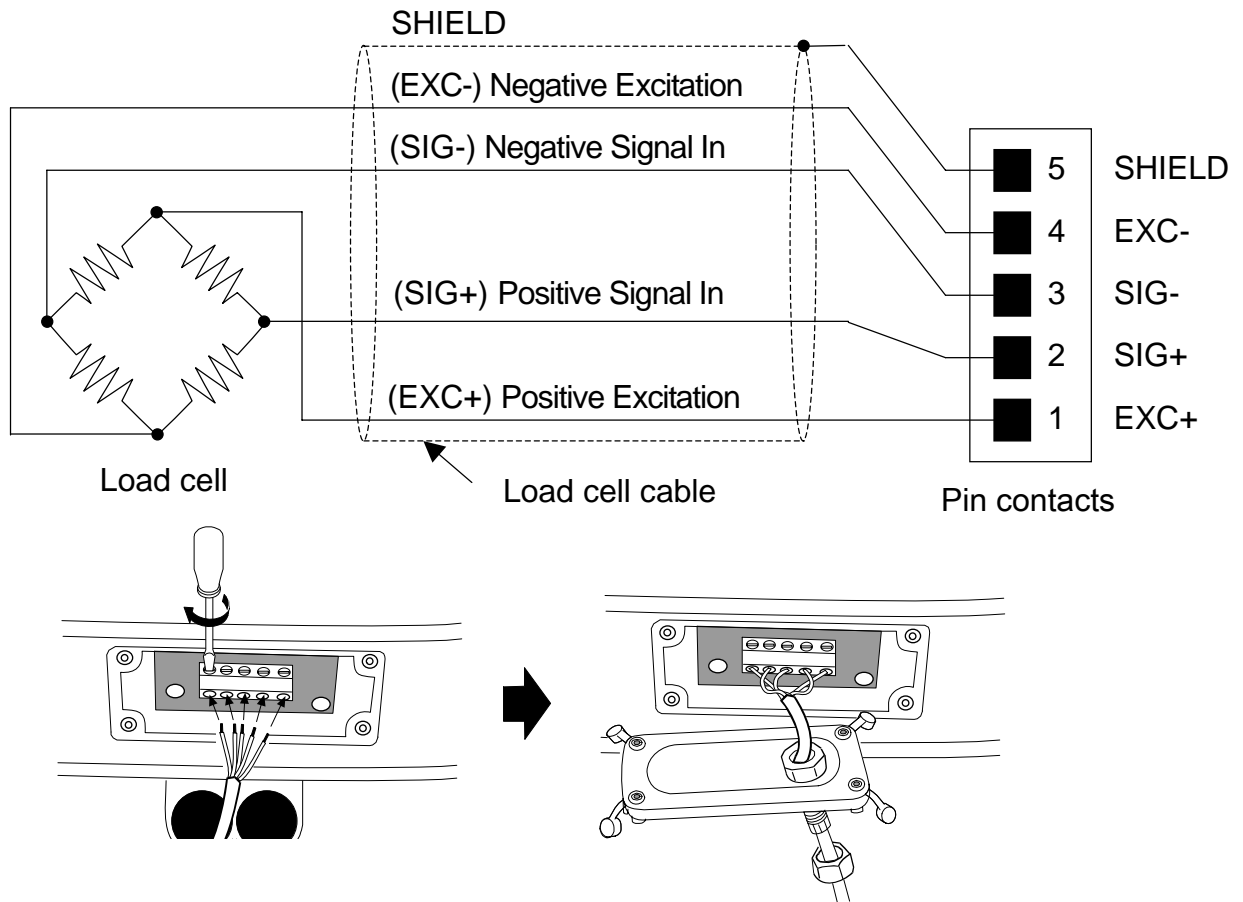

5. Tighten the cable clamp locking nut to secure the load cell cable.

6. Close the load cell panel by securing the four screws and cover the screws using the screw protection caps.

5-3. Verifying Load Cell Output and Input Sensitivity

The input sensitivity is 0.2 μV /division or more. When designing a weighing scale, the following calculation formula should be satisfied.

- The input sensitivity requires a change in output voltage, from the weighing device, to change the display value as a one digit step. In order to achieve a scale with stable performance, select the input sensitivity as large as possible.

Calculating formula:

$$0.2 \leq \frac{E \times B \times d}{A \times n}$$

A : Rated capacity of load cell

B : Rated output (mV/V)

d : Minimum division

E : Excitation voltage (mV) = 5000 mV for SW-D

n : Number of load cells

Example of calculation:

In the case of designing a scale with a capacity of 60 kg and minimum division of 0.005 kg, using one load cell with a rated capacity of 100 kg and rated output of 1 mV/V:

| | | |
|------------------------------|---------------------|--|
| Rated capacity of Load cell: | A = 100 kg | $\frac{5000 \times 1 \times 0.005}{100 \times 1} = 0.25 > 0.2$ |
| Rated output: | B = 1 mV/V | |
| Minimum division: | d = 0.005 kg | |
| Excitation voltage: | E = 5000 mV | |
| Number of load cells: | n = 1 | |

Therefore, there is no problem with this design.

5-4. Setting Up the Indicator

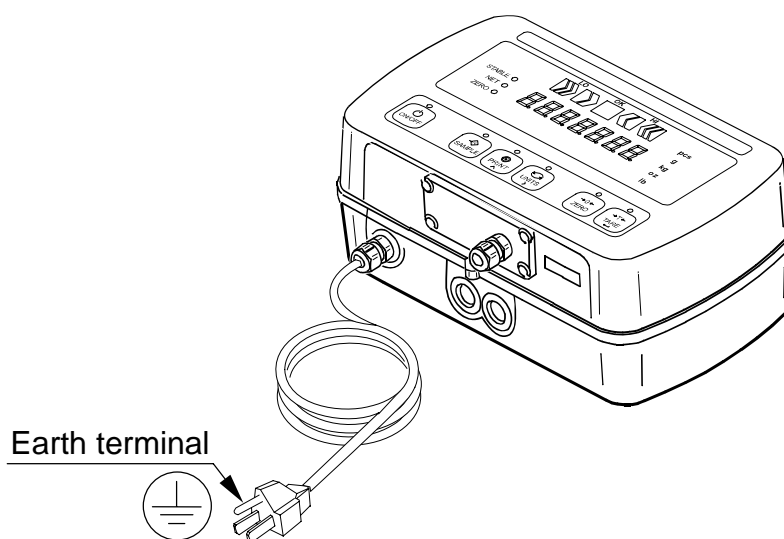

- ❑ After confirming that nothing is touching the key switches on the indicator, connect the main power cable to a power source that has an earth ground terminal.

5-5. Parameter Settings and Calibration

When a platform scale is initially set up, it is necessary to set some parameters and calibrate it using a calibration weight.



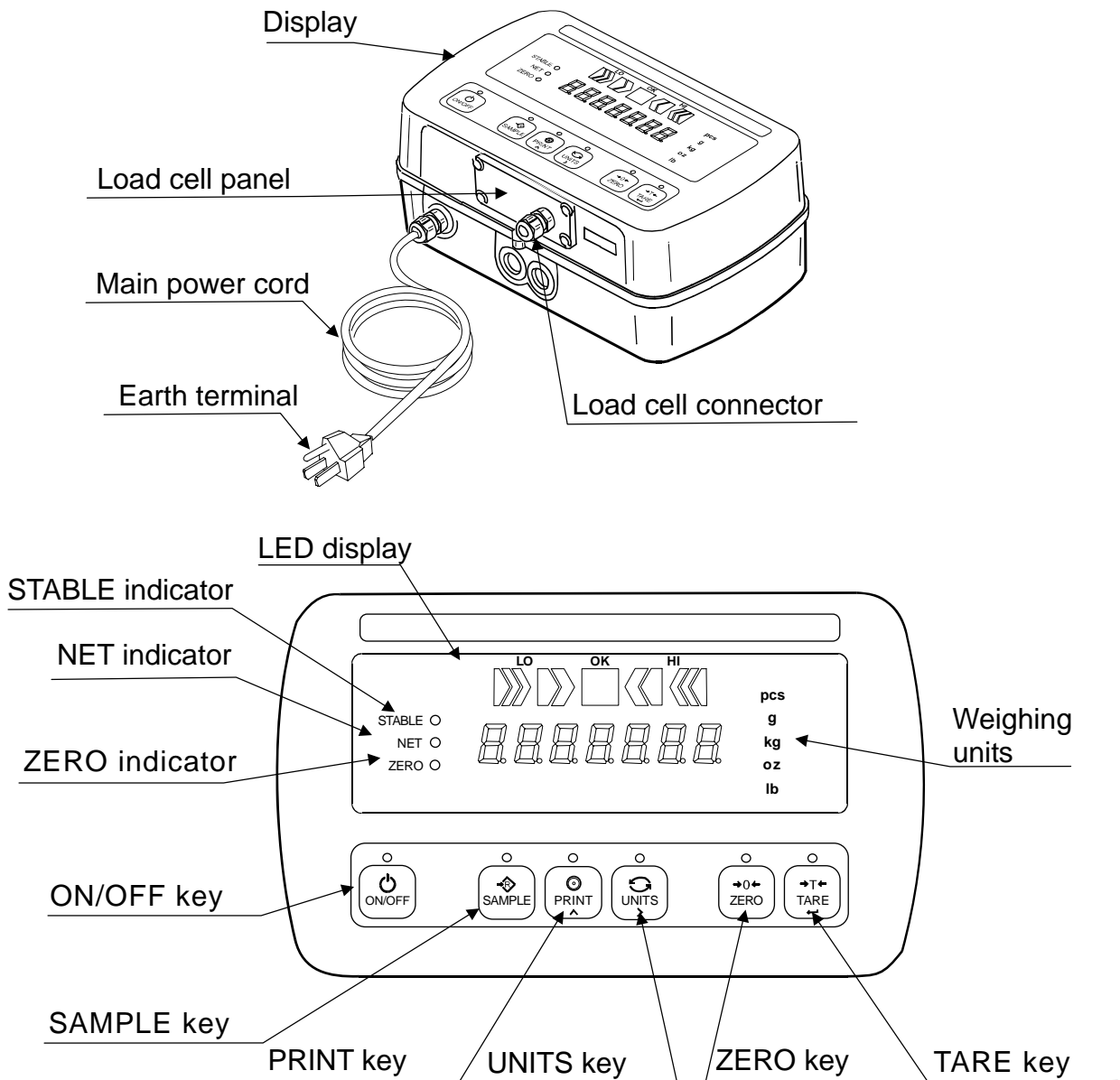

See “**8. SETTING FUNCTIONS OR UNITS FOR USE**” to set parameters and “**7. CALIBRATION**” to calibrate the scale.

6. DESCRIPTION OF EACH PART

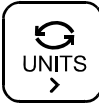

Symbols

| Symbol | Description |
|----------------|--|
| STABLE ○ | Turns on when the weight value is stable. |
| NET ○ | Turns on when the NET weight is displayed. (The tare operation is in progress.) |
| ZERO ○ | Turns on when zero is displayed. |
| »»□«« | Turns on when the comparator results are displayed. |
| Weighing units | "pcs", "g", "kg", "oz" and "lb" are available. A selected unit turns on. |

| Key | Description |
|---|---|
|  | <p><u>ON/OFF key</u></p> <p>Turns the power ON or OFF. When turned ON, the scale will be automatically set to zero (power-on zero). To turn the power OFF, press and hold the key. Note: If pressing the key does not turn the power ON immediately, keep pressing the key.</p> |
|  | <p><u>SAMPLE key</u></p> <p>In the counting mode (“pcs”), goes to the unit weight storing mode. Press and hold to go to the comparator value setting mode.</p> |
|  | <p><u>PRINT key</u></p> <p>Outputs the weight value to the printer. In the setting mode, this key is used to increase the value of the selected blinking digit by one.</p> |
|  | <p><u>UNITS key</u></p> <p>Switches the weighing unit. In the setting mode, this key is used to shift the blinking digit to the right.</p> |
|  | <p><u>ZERO key</u></p> <p>Zeroes the scale and sets the display to zero.</p> |
|  | <p><u>TARE key</u></p> <p>Subtracts the tare (container) weight placed on the weighing pan. In the setting mode, this key is used to store the setting value and proceed to the next step.</p> |

7. CALIBRATION

When calibrating, refer to this set up instructions. (The contents of SW instruction manual are not the same as this set up instructions.)

7.1. Items of the calibration mode

- ❑ The calibration mode has the following three functions.
 - Setting of the weighing capacity, minimum division, and decimal point position.
 - Gravity acceleration correction
 - Calibration using a weight

- ❑ How to enter the calibration mode
 1. Make sure that the scale is in the weighing mode (displaying “kg”, “g”, “lb”, “oz” or “pcs”).
 2. Remove the screw protection caps on the load cell panel on the bottom of the display. Loosen the four screws and then open the load cell panel. The calibration (CAL) switch is located inside.
 3. Press the CAL switch. The indicator displays “CAL SET”. (And proceed to “7.2”, “7.3”, or “7.4”.)

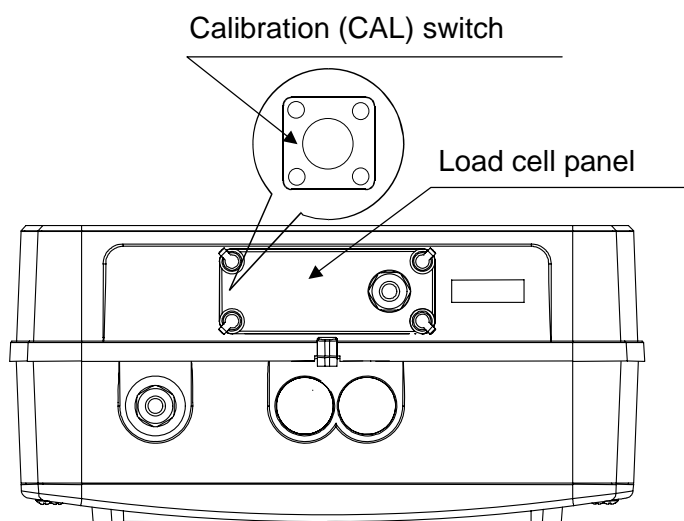

The chart below shows the relation between each item and the key operation in the calibration mode.

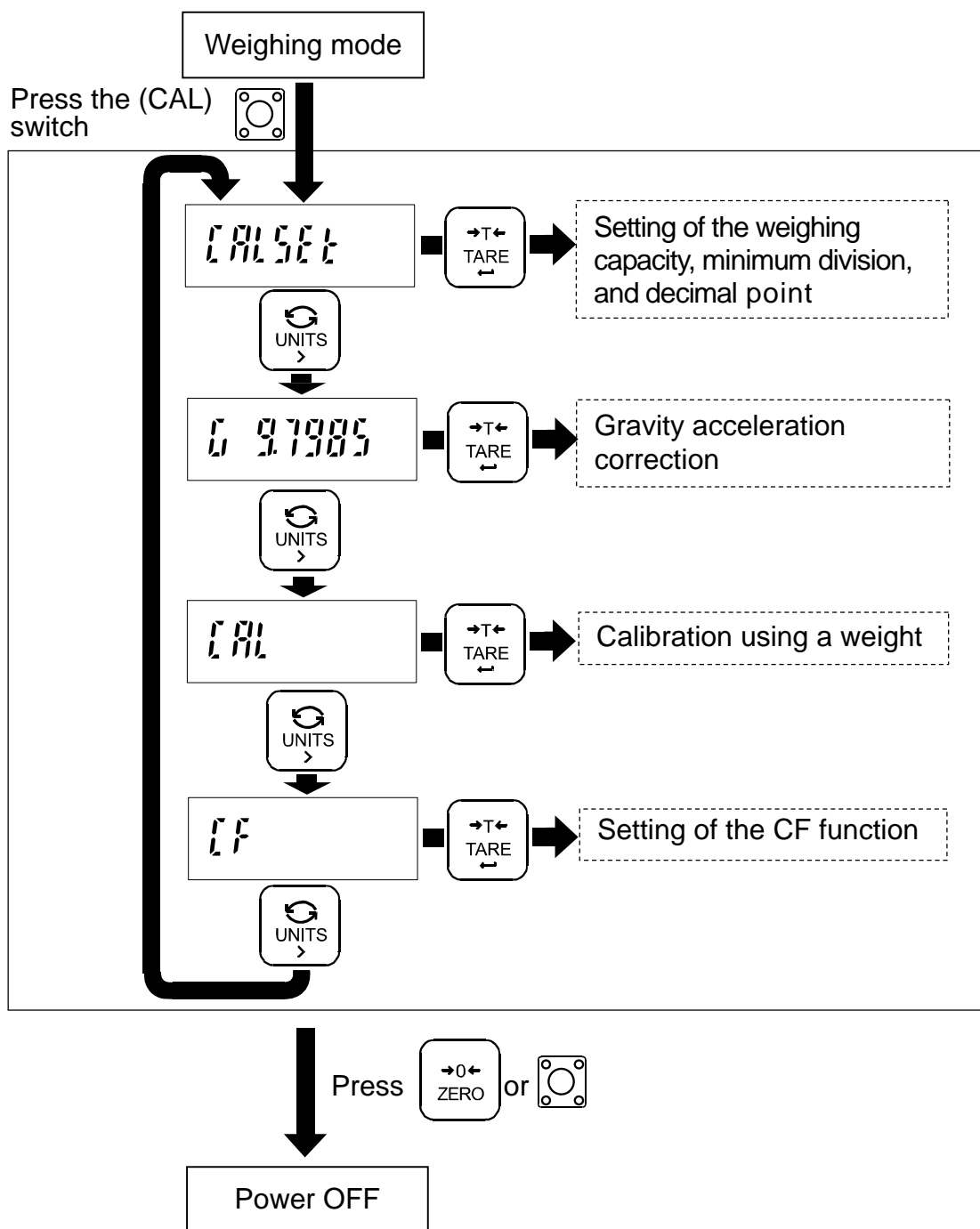

Press the **UNITS** key to select an item and press the **TARE** key to execute it. To exit from the calibration mode, press the **ZERO** key or the CAL switch. The indicator turns the power off. (Or press the **ON/OFF** key to turn the power off.)

7.2. Setting of the weighing capacity / minimum division / decimal point position

Set the weighing capacity, minimum division, and decimal point position. Be sure to perform these setting first when connecting to a load cell (base unit). The indicator does not require setting each time, if nothing is to be changed.

1. Refer to “7.1. Items of the calibration mode”, to enter the calibration mode. The indicator displays “CAL SET”.
2. Press the **TARE** key to enter the setting mode of the weighing capacity, minimum division, and decimal point position.
3. The indicator displays the currently set minimum division and calibration unit. (Display example: “d- 1 kg”) The blinking digit indicates the minimum division. Press the **PRINT** key to select 1, 2, or 5. The unit indicates the calibration unit. Press the **SAMPLE** key to select either “kg” or “lb”. Press the **TARE** key to store the currently set minimum division and calibration unit, and proceed to the next step.
4. After displaying “CAP”, the indicator displays the currently set weighing capacity and decimal point position. (Display example: “006000 kg”) Set the weighing capacity and decimal point position using the following keys:

| | |
|--------|--|
| MODE | Shift the blinking digit to the right. |
| PRINT | Increases the number (+1) at the blinking digit. |
| SAMPLE | Shift the decimal point position. |

Press the **TARE** key to store the currently displayed weighing capacity and decimal point position, and proceed to the next step.

- ❑ Available setting range of the resolution is 60,000 or less. The resolution is the value that divides the weighing capacity by the minimum division. (Decimal point position is ignored.)

5. After displaying “End”, the indicator displays “CAL SET”, and the setting is complete.

After setting the weighing capacity, minimum division, and decimal point position, be sure to perform “7.4. Calibration using a weight”.

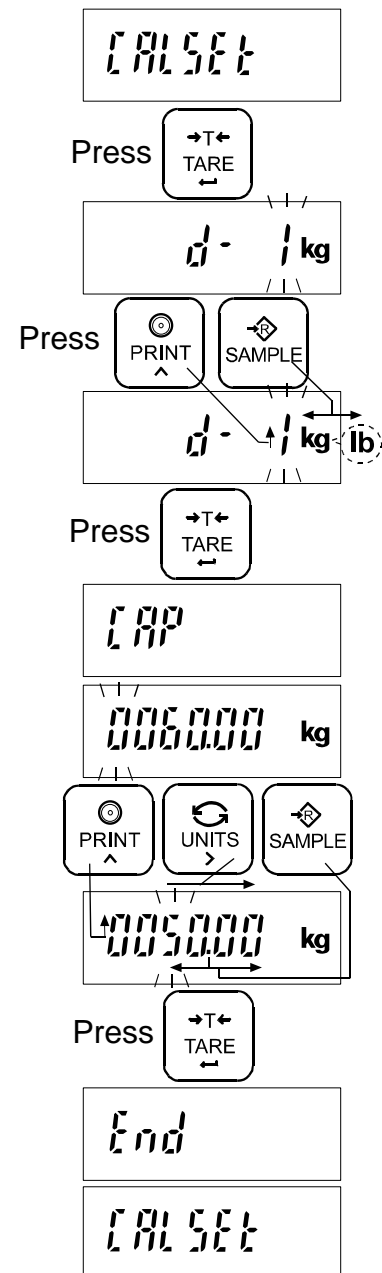

7.3. Gravity acceleration correction

When the scale is first used or has been moved to another location, it should be calibrated using a calibration weight.

But if a calibration weight is not available, the gravity acceleration correction will compensate the scale. Change the gravity acceleration value stored in the scale to the value of the area where the scale will be used. Refer to the gravity acceleration map at the end of this manual.

Note: Gravity acceleration correction is not required when the scale will be calibrated using a calibration weight at the place where it is to be used.

1. Refer to “7.1. Items of the calibration mode”, to enter the calibration mode. The indicator displays “CAL SET”.

2. Press the **UNITS** key to display “0 9.7985” (gravity acceleration value).

3. Press the **TARE** key to enter the gravity acceleration value setting mode.

4. Change the displayed value using the following keys.

UNITS To shift the blinking digit to the right.

PRINT To increase the value of the blinking digit by one.

5. Press the **TARE** key. The setting value is stored and “End” is displayed. After displaying “0 9.7985” (gravity acceleration value), the setting is complete.

6. When calibration using a calibration weight is to be performed, go to step 3 of “7.4. Calibration using a weight”.

To finish the setting procedure, press the **ZERO** key or the CAL switch. The indicator turns the power off.

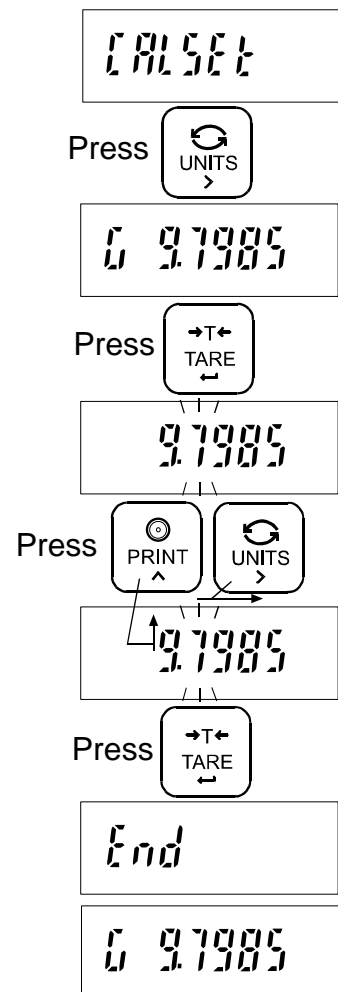

7.4. Calibration using a weight

This function adjusts the scale (indicator) for accurate weighing.

Calibration must be done when the SW-D is initially connected to a load cell (base unit) or the combination is changed.

Calibration may also be required according the changes in the environment.

- When the scale (indicator) has been moved.
- When the ambient environment has significantly changed.
- For regular calibration.

Note: Prepare a weight, preferably a weight with the same value as the weighing capacity of the scale to be calibrated. Note that the calibration weight value can be changed.

1. Turn the power ON and warm up the scale for at least half an hour.

- Change the function setting "POFF" or place something on the weighing pan to disable the auto power-off function.

2. Refer to "7.1. Items of the calibration mode", to enter the calibration mode. The indicator displays "CALSET".

3. Press the **UNITS** key twice and display "CAL".

4. Press the **TARE** key. "CAL 0" is displayed. Confirm that nothing is placed on the weighing pan and wait for the STABLE indicator to turn on.

5. Press the **TARE** key. The scale calibrates the zero point and displays the value of the calibration weight (SPAN calibration).

- The calibration weight value is equal to the weighing capacity. (factory setting)

- If you want to calibrate only the zero point without calibrating SPAN, press the **ZERO1** key. After "End" is displayed, go to step 9.

6. To calibrate with a weight different from the weighing capacity, change the displayed value using the following keys.

UNITS To shift the digit that is blinking to the right.

PRINT To increase the value of the blinking digit by one.

- Using a weight with the same value as the weighing capacity is recommended. If other weights are used, use one with a value greater than two-thirds of the capacity.

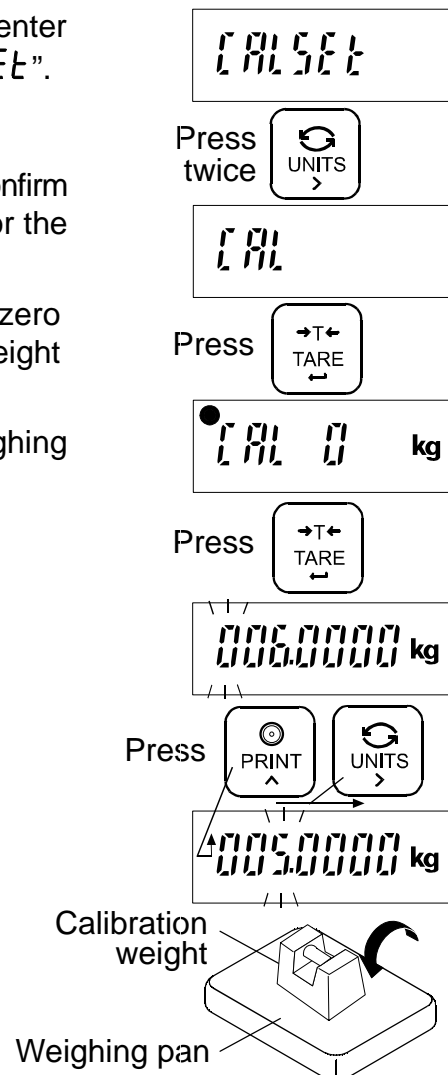

7. Place the calibration weight with the same value as displayed on the weighing pan, and wait for the STABLE indicator to turn on.
8. Press the TARE key. The scale calibrates SPAN and “End” is displayed. After displaying “CAL”, the setting is complete.
9. To finish the setting procedure, press the ZERO key or the CAL switch. The indicator turns the power off.

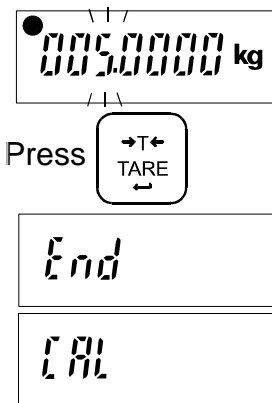

Note: If the scale will be moved to another location, set the gravity acceleration value for the new location and calibrate the scale according to the procedure above. Refer to the previous section to set the gravity acceleration value.

8. SETTING FUNCTIONS OR UNITS FOR USE

The indicator has CF function settings to specify the indicator performance. After installing the indicator, the indicator does not require resetting or changing of this CF function as far as it is used normally. If you want to maintain only the needed units, set using this function. The parameters set in the CF function settings and unit setting are maintained even if the power is turned OFF.

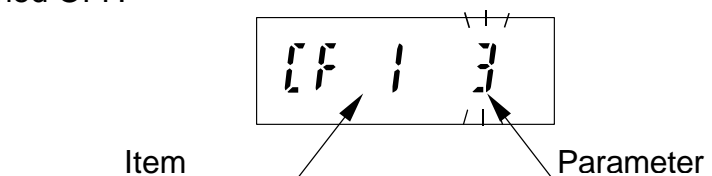

8.1. Setting of the CF function

1. Refer to "7.1. Items of the calibration mode", to enter the calibration mode. The indicator displays "CAL SET".
2. Press the **MODE** key three times to display "CF".
3. Press the **TARE** key to display the setting item.
4. Select the setting item and parameter using the following keys:
 - UNITS** Proceed to next setting item.
 - PRINT** Increases the number (+1) at the blinking digit.
(Change the parameter)
 - When the currently stored set is changed, the STABLE indicator "●" turns off.
 - Changing the parameter using the **PRINT** key at CF1, 2, 8 or 12 is not available.
5. Press the **TARE** key to store the setting. After displaying "End", the indicator displays "Un it" and proceeds to the unit setting mode.
 - To proceed, without storing the CF function setting, press the **ZERO** key. After displaying "Un it", proceed to the use unit setting mode. (Display example: "11 10000 pcs")
6. When the unit setting is to be performed, go to step 5 of "8.2. Setting the unit for use".
When the unit setting is not to be performed, press the **ZERO** key. After displaying "CF", the setting is complete.
 - To adjust to the designed scale specification, set other items by following the procedure described above.

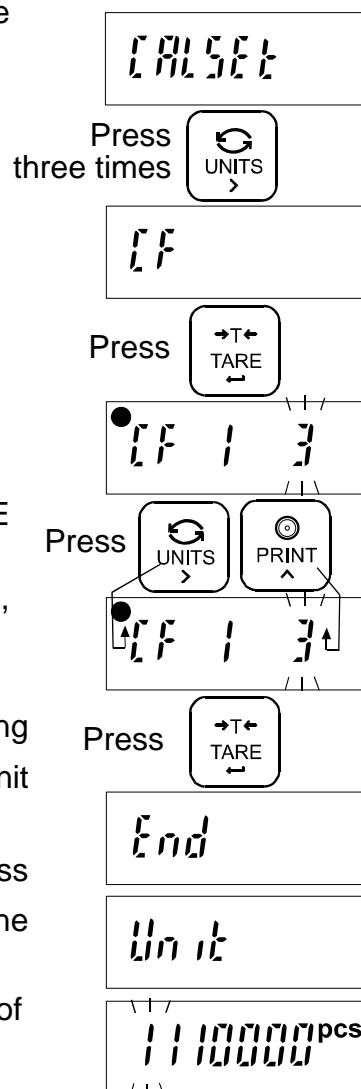

8.2. Setting unit for use

1. Refer to “7.1. Items of the calibration”, to enter the calibration mode. The indicator displays “CALSET”.

2. Press the **MODE** key three times to display “CF”.

3. Press the **TARE** key to display the setting item.

4. To proceed without storing this setting item, press the **ZERO** key.

After displaying “Unit”, proceed to the unit setting mode.
(Display example: “1110000 pcs”)

5. Select the unit to be used, using the following keys.

UNITS Select the unit (Shift the blinking unit to the right)

PRINT Set whether the selected unit is available (0) or not available (1). (Change the number of the blinking digit to “0” or “1”.)

□ About the unit setting mode

Each of the display digits are assigned to a unit setting.

(The setting at the first and fourth digit is not available.)

| Display assignment | 7 | 6 | 5 | 4 | 3 | 2 | 1 |
|--------------------|-----|---|----|--------------|----|----|--------------|
| Unit | pcs | g | kg | Set disabled | oz | lb | Set disabled |

-The unit during selection is indicated.

-With each digit, if setting to “0”, its unit is not available, and if setting to “1”, its unit is available.

(Only when set to “1”, is a unit available.)

Even if a unit is stored, availability for use depends on the weighing capacity and resolution.

Example) When setting to “1010000 pcs”, only “pcs” and “kg” are available as units.

6. Press the **TARE** key to store the setting. After displaying “End”, the indicator displays “CF”, and the setting is complete.

□ If you want to proceed without storing the setting of the unit setting mode, press the **ZERO** key. After displaying “CF”, the setting is complete.

CALSET

Press three times **UNITS**

CF

Press **TARE**

Unit

Press **ZERO**

1110000 pcs

1110000 pcs

Press **PRINT** **UNITS**

1010000 pcs

Press **TARE**

End

CF

8.3. CF Function list

| Item | Parameter | Description | |
|--|-----------|--|---|
| Used internally [F 1] | ◆ 3 | Not available for setting change | |
| Used internally [F 2] | ◆ 0 | Not available for setting change | |
| Zero tracking [F 3] | 0 | Not available for setting of function "t r c" (It is fixed to "t r c 1") | When "[F 3 0]", "t r c" has no function. |
| | ◆ 1 | Available for setting of function "t r c" | |
| Power on zero range [F 4] | 0 | None | Calibration zero reference |
| | 1 | ±10% of weighing capacity | |
| | ◆ 2 | ±50% of weighing capacity | |
| | 3 | ±100% of weighing capacity | |
| Calculation of tare [F 5] | 0 | Tare by displayed division | |
| | ◆ 1 | Tare by internal count | |
| Stable indicator of during tare [F 6] | 0 | During tare, stable indicator has no function | |
| | ◆ 1 | During tare, stable indicator turns on | |
| Tare clear by zero operation [F 7] | 0 | Tare is not cleared by zero operation | |
| | ◆ 1 | Tare is cleared by zero operation | |
| Used internally [F 8] | ◆ 3 | Not available for setting change | |
| Minus and printing limit [F 9] | ◆ 0 | Non-limit | Refer to below note. |
| | 1 | Limit has function | |
| Auto tare function [F 10] | 0 | No auto tare function | When "[F 10 0]", "A t - t" "A t - F" has no function. |
| | ◆ 1 | Auto tare function | |
| Stable detection range [F 11] | 0 | Not available for setting of function "S t - b" (It is fixed to "S t - b 0") | When "[F 11 0]", "S t - b" has no function. |
| | ◆ 1 | Available for setting of function "S t - b" | |
| Used internally [F 12] | ◆ 0 | Not available for setting change | |

◆ Factory setting

Note: About minus and printing limit setting ("[F 9]")

When setting "[F 9]" to "1", the indicator has the following limit.

When the total weight is -19d or less, the indicator displays "-E".

(*d = minimum division)

When the total weight is minus, the indicator does not perform the printing.

9. OPTIONS

- ❑ For details of HC-02i, SW-03, and SW-04, refer to the “OPTIONS” in the SW series instruction manual.

9.1. SW-11 Display stand / Wall-mount

- ❑ SW-11 provides the function as a display stand or a wall-mount for the SW-D.

Attaching to SW-11

1. Attach the SW-11 to the display using the four screws provided.
2. Adjust the display angle using the two clamps on the SW-11.

After loosening the two clamps on the SW-11, adjust the display angle, and re-tighten the two clamps.

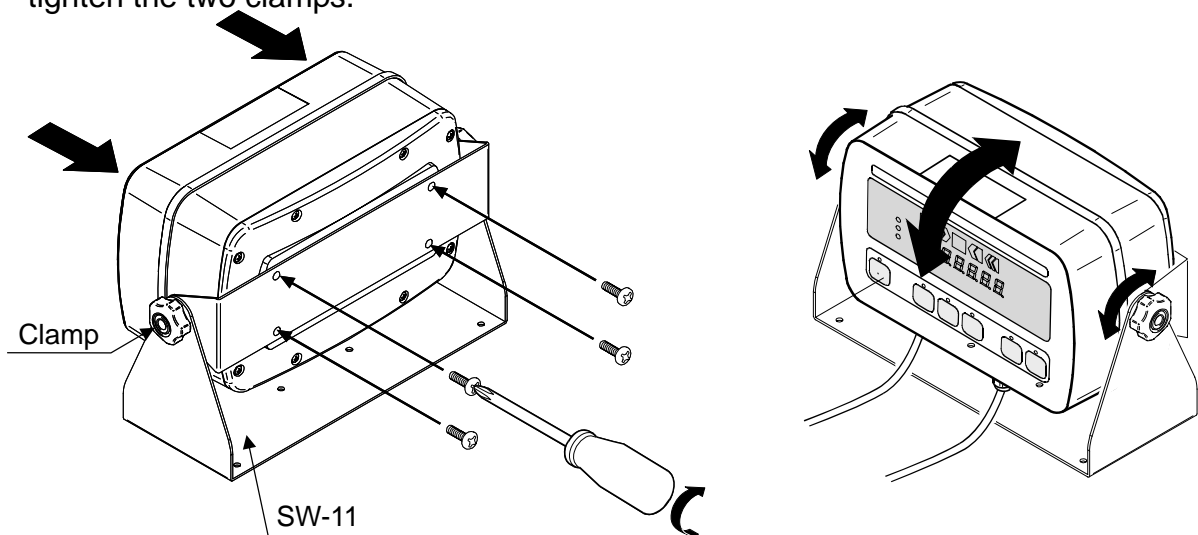

3. If you want to use the SW-11 as wall-mount bracket, after fixing only the stand part of the SW-11 on the flat wall by using the screws, attach the display to the SW-11. (These screws are not provided.)

For details of the installing dimension, refer to “11.2. External dimensions”.

10. MAINTENANCE

10.1. Notes on maintenance

- Do not disassemble the indicator. Contact your local A&D dealer if the indicator needs service or repair.
- Use the original packaging for transportation.
- Do not use organic solvents to clean the indicator. Use a warm lint free cloth dampened with a mild detergent.
- Calibrate the indicator periodically to maintain the weighing accuracy.

10.2. Error codes

Overload error

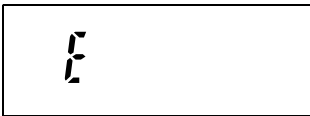

Indicates that an object beyond the weighing capacity has been placed on the weighing pan.
Remove the object from the weighing pan.

Over range error



When setting “[F 9]” to “/”, indicates that total weight is $-19d$ or less. (d = minimum division)
(In the case of turning on the stable indicator, setting the display to zero by pressing the **ZERO** key is available.)

Unit weight error

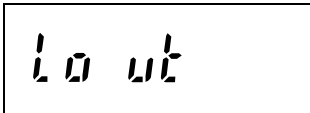

Indicates that the sample weight is too light to set the unit weight in the counting mode.

CAL error

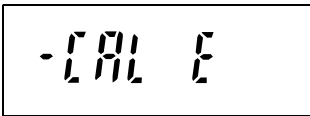

Indicates that the calibration procedure is canceled because the calibration weight is too light.
Check that the weighing pan is installed properly and the mass of the calibration weight.

Low battery



Indicates that the HC-02i battery is depleted.
Charge the battery immediately.

Other

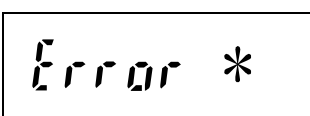

There may be an internal malfunction.
(* indicates an error number.)

Note: If the error persists or other errors occur, contact your local A&D dealer.

11. SPECIFICATIONS

11.1. Specifications

| | | |
|------------------------------|------|---|
| Input sensitivity | | 0.2 μ V / d min. (d: minimum division) |
| Input signal range | | -16 mV ~ 16 mV |
| Load cell excitation voltage | | 5 V DC \pm 5% (no remote sensing) |
| Load cell drive capacity | | Up to 4 x 350 ohm load cells |
| Temperature coefficient | Zero | \pm (0.2 μ V \pm 0.001% of zero adjustment voltage) / $^{\circ}$ C (typ.) |
| | Span | \pm 0.001% / $^{\circ}$ C of reading (typ.) |
| linearity | | \pm 0.01 % of full scale |
| Maximum display resolution | | 60,000 |
| Display | | Weight display: 7 segment LED display (Character height 14.6 mm) Comparison result: red / yellow / green / yellow / red LED |
| Display update | | Approximately 10 times per second |
| Operating temp. | | -10 $^{\circ}$ C ~ 40 $^{\circ}$ C / 14 $^{\circ}$ F ~ 104 $^{\circ}$ F |
| Power supply | | AC main (100V +10%/-15%, 50/60 Hz 20VA) or SLA Battery (option), available use time approximately 70 hours* Main power cord length: Approximately 3 m |
| Dimension | | 255 (W) x 119 (D) x 179 (H) mm |
| Weight | | Approximately 2.1 kg |

* In the case of one 350 ohm load cell, no other option, and turning on comparator LED (The available use times depend on the condition of the battery, how the battery is used and the environment.)

Options

- HC-02i SLA Sealed Lead Acid battery (YUASA NP4-6 recommended)
- SW-03 RS-232C / Relay output
- SW-04 RS-422 / 485
- SW-11 Display stand / Wall-mount

Note: The options, SW-03 and SW-04, can not be used at the same time.

11.2. External dimensions

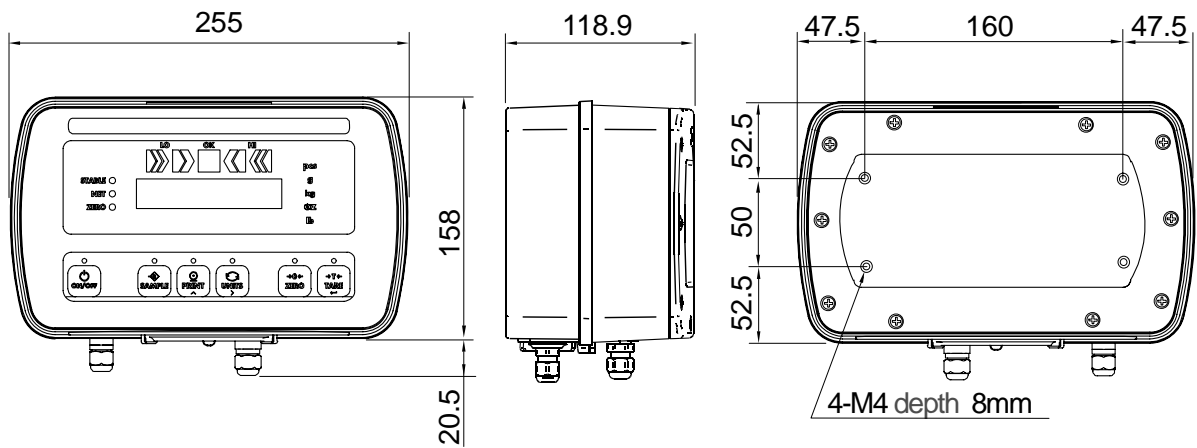

● When attaching to SW-11

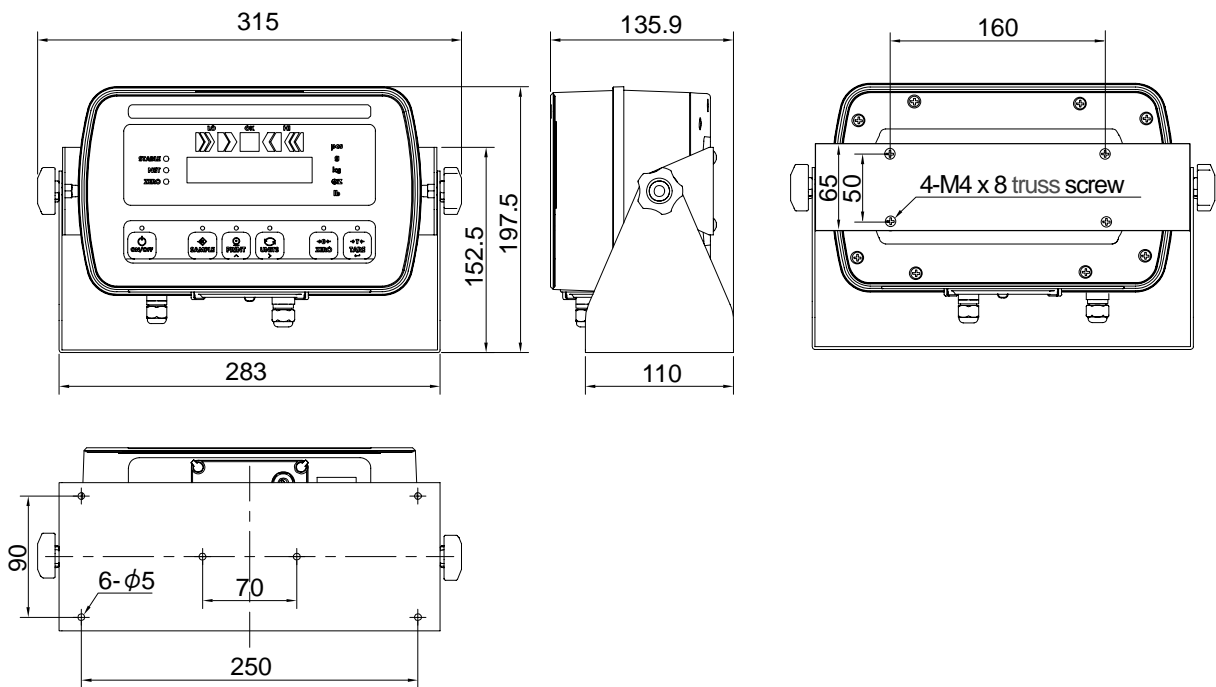

Unit: mm

GRAVITY ACCELERATION MAP

Values of gravity at various locations

| | | | |
|--------------------|------------------------|----------------|------------------------|
| Amsterdam | 9.813 m/s ² | Manila | 9.784 m/s ² |
| Athens | 9.807 m/s ² | Melbourne | 9.800 m/s ² |
| Auckland NZ | 9.799 m/s ² | Mexico City | 9.779 m/s ² |
| Bangkok | 9.783 m/s ² | Milan | 9.806 m/s ² |
| Birmingham | 9.813 m/s ² | New York | 9.802 m/s ² |
| Brussels | 9.811 m/s ² | Oslo | 9.819 m/s ² |
| Buenos Aires | 9.797 m/s ² | Ottawa | 9.806 m/s ² |
| Calcutta | 9.788 m/s ² | Paris | 9.809 m/s ² |
| Cape Town | 9.796 m/s ² | Rio de Janeiro | 9.788 m/s ² |
| Chicago | 9.803 m/s ² | Rome | 9.803 m/s ² |
| Copenhagen | 9.815 m/s ² | San Francisco | 9.800 m/s ² |
| Cyprus | 9.797 m/s ² | Singapore | 9.781 m/s ² |
| Djakarta | 9.781 m/s ² | Stockholm | 9.818 m/s ² |
| Frankfurt | 9.810 m/s ² | Sydney | 9.797 m/s ² |
| Glasgow | 9.816 m/s ² | Taichung | 9.789 m/s ² |
| Havana | 9.788 m/s ² | Tainan | 9.788 m/s ² |
| Helsinki | 9.819 m/s ² | Taipei | 9.790 m/s ² |
| Kuwait | 9.793 m/s ² | Tokyo | 9.798 m/s ² |
| Lisbon | 9.801 m/s ² | Vancouver, BC | 9.809 m/s ² |
| London (Greenwich) | 9.812 m/s ² | Washington DC | 9.801 m/s ² |
| Los Angeles | 9.796 m/s ² | Wellington NZ | 9.803 m/s ² |
| Madrid | 9.800 m/s ² | Zurich | 9.807 m/s ² |

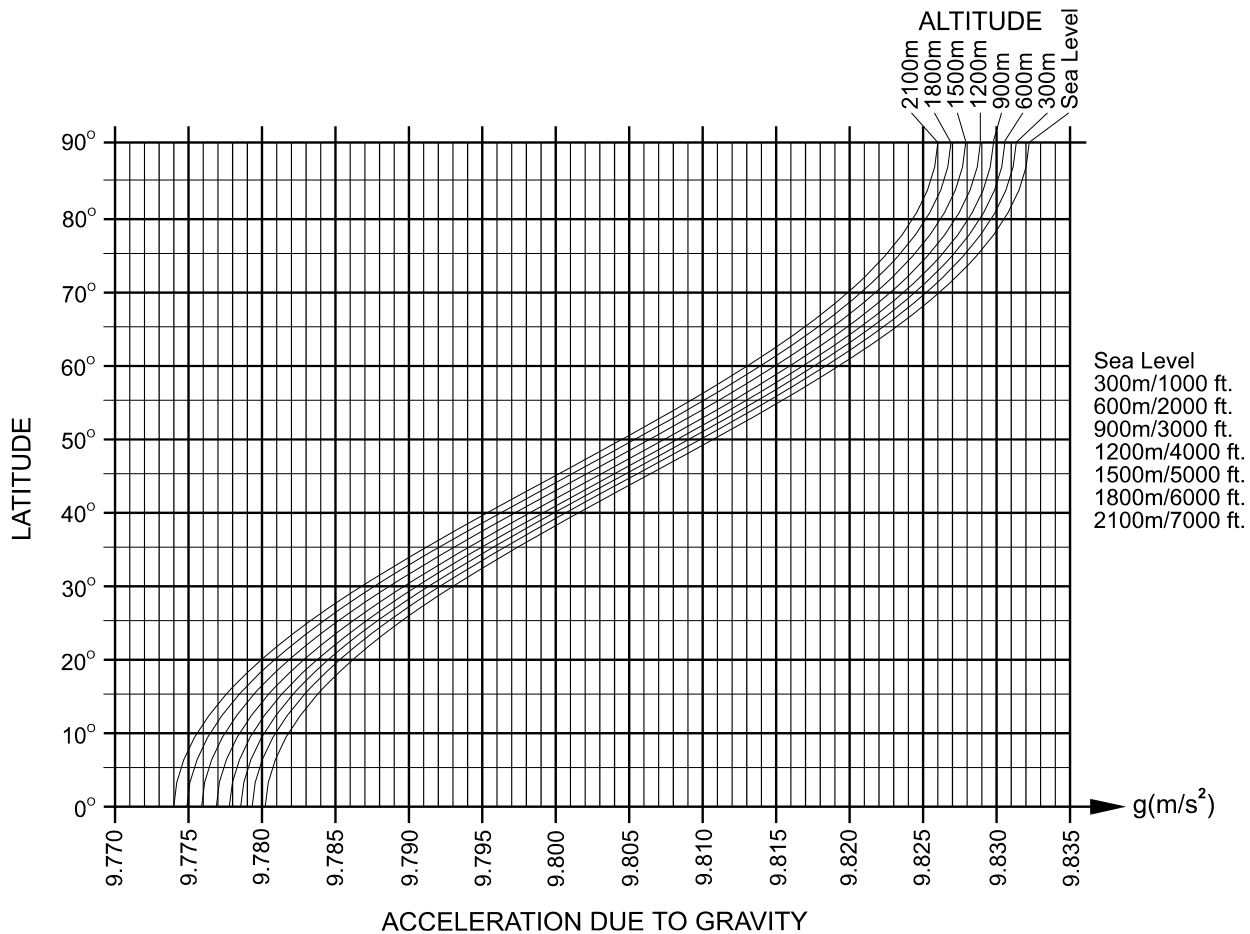

World map

