

IP67

Compact Bench Scale

INSTRUCTION MANUAL

SJ-3000WP
SJ-6000WP
SJ-15KWP
SJ-30KWP

© 2015 A&D Company, Limited. All rights reserved.

No part of this publication may be reproduced, transmitted, transcribed, or translated into any language in any form by any means without the written permission of A&D Company, Limited.



The contents of this manual and the specifications of the instrument covered by this manual are subject to change for improvement without notice.

CONTENTS

1.	SAFETY PRECAUTIONS	2
2.	PARTS DESCRIPTION	3
3.	PREPARATION.....	4
3.1.	Installing / Exchanging Batteries	4
3.2.	Setting Up The Scale	4
4.	DISPLAY AND SYMBOLS	5
4.1.	Display	5
4.2.	Symbols	5
4.3.	Operations And Functions Of Switches.....	6
5.	OPERATION	7
5.1.	Basic Weighing Operation.....	7
5.2.	Notes About Operations	7
5.3.	Weight Display Resolution	8
6.	SELECTING A WEIGHING UNIT.....	9
6.1.	Storing The Weighing Unit	9
6.2.	Selecting The Weighing Unit.....	9
7.	COUNTING MODE	10
8.	COMPARATOR.....	11
8.1.	The Formula To Compare	12
8.2.	Entering The Comparator Values.....	14
9.	AUTO-TARE.....	15
10.	CALIBRATION	16
10.1.	Calibration Mode	16
10.2.	Gravity Acceleration Correction.....	18
10.3.	Calibration Using A Weight	19
10.4.	Restoring The Calibration Data To The Factory Set Values.....	20
11.	FUNCTION SETTINGS.....	21
11.1.	Setting The Parameters	21
11.2.	Restoring The Function Settings To The Factory Set Values.....	22
11.3.	Function List.....	23
12.	MAINTENANCE	27
12.1.	Notes On Maintenance.....	27
12.2.	Pick cleaning.....	27
12.3.	Error Codes.....	27
13.	SPECIFICATIONS	29
14.	GRAVITY ACCELERATION.....	32

1. SAFETY PRECAUTIONS

All safety messages are identified by the following, "**WARNING**" or "**CAUTION**", of ANSI Z535.4 (American National Standard Institute: Product Safety Signs and Labels). The meanings are as follows:

 WARNING	A potentially hazardous situation which, if not avoided, could result in death or serious injury.
 CAUTION	A potentially hazardous situation which, if not avoided, may result in minor or moderate injury.

- This manual is subject to change without notice at any time to improve the product.
- Product specifications are subject to change without any obligation on the part of the manufacturer.
- When using the SJ-WP series, the following safety precautions should always be followed.

WARNING

Internal service or adjustment to this product should be performed by a qualified person.

CAUTION

Avoid installing the scale in direct sunlight, which may cause discoloration or malfunctions.

Do not mix battery types, or new and old batteries. Replace with all new batteries at the same time.

If the scale is not to be used for a long period of time, remove all batteries from the battery compartment to avoid leakage.

Avoid overloading the scale.

Avoid using the weighing platform to move the scale, as that could cause damage to the scale.

Avoid chemical solvents. Clean the scale with water.

IP67



Degrees of protection against water: Protected against temporary submergence.

Degrees of protection against solid foreign objects: Dust-tight.

International **P**rotection of IEC60529.

2. PARTS DESCRIPTION

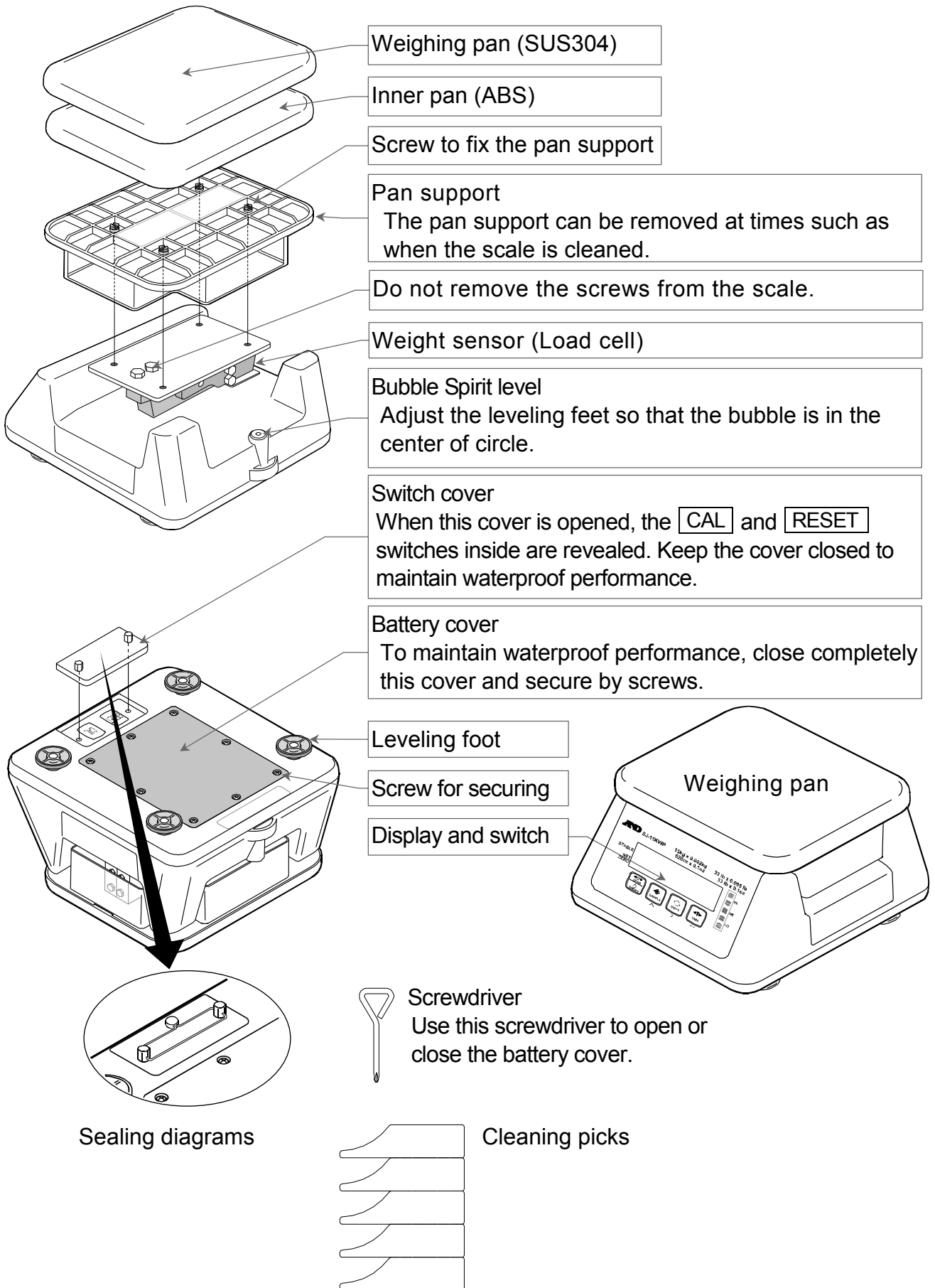

3. PREPARATION

3.1. Installing / Exchanging Batteries

The batteries are not included with the product. Prepare 6 x "D" size (R20P or LR20) dry-cell batteries.

When the  mark is displayed, exchange the old batteries with new ones.

1. Loosen the screws for securing the battery cover using the provided screwdriver, and remove the battery cover.
2. Remove all the old batteries from the battery compartment.
3. Install six new batteries properly according to the + and - indicators of polarity in the battery compartment.
4. Close the battery cover, and tighten the screws for securing the battery cover.

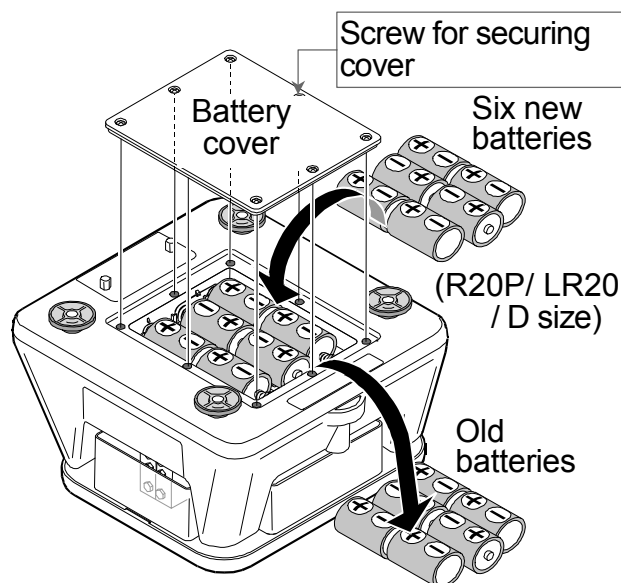

CAUTION

- Do not mix used and new batteries. Do not mix the different types of batteries. That may cause damage to the batteries or the scale.
- Take care of the polarity of batteries. The polarity marks are shown in the battery compartment.

3.2. Setting Up The Scale

CAUTION

- Avoid installing the scale in direct sunlight, that may cause discoloration or malfunctions. Place your SJ-WP on a firm weighing table so that the scale is level. The scale will not perform accurately when it is not level.
- Place the scale on a firm surface and adjust the feet so that the bubble of the spirit level is in the center of the circle.



4. DISPLAY AND SYMBOLS



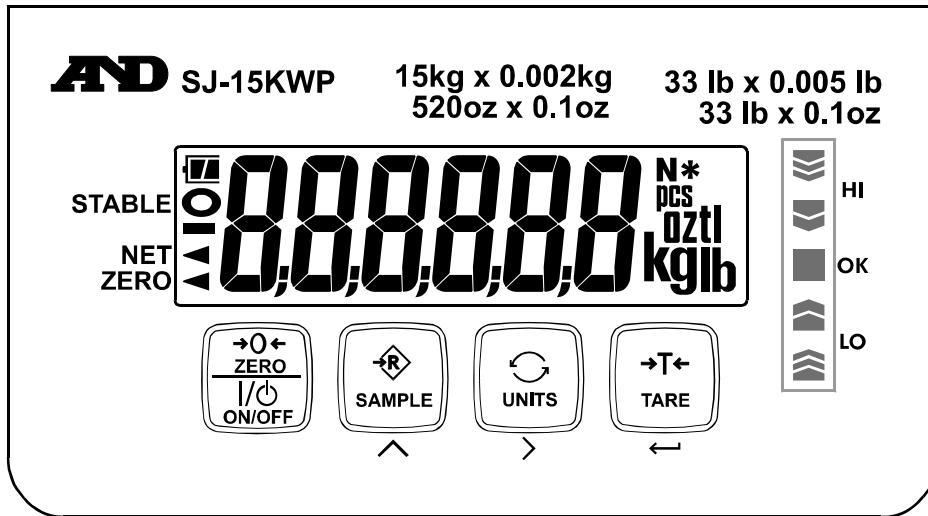

4.1. Display

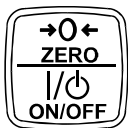
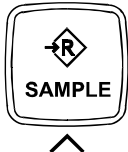
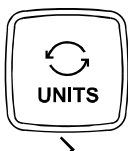

4.2. Symbols

Symbol	Description
STABLE	Turns on when the weight value is stable.
NET	Turns on when the NET weight is displayed. (The tare operation is in progress.)
ZERO	Turns on when zero is displayed.
 Comparator LEDs	Turns on when the comparator results are displayed.
Weighing units	"lb", "oz", "ozt", "lb-oz", "tl-s", "tl-h", "tl-t", "t", "pcs", "N", "g" and "kg" are available. A selected unit is displayed.
*	Turns on while a switch is touched.
 Battery indicator	The battery indicator changes as the battery capacity decreases, as shown below: New → Replace the batteries.

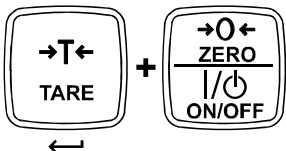
4.3. Operations And Functions Of Switches

Switch	Description
	<p>When the scale is turned off: Press the switch to turn ON the scale. The scale will be automatically set to zero (power-on zero).</p> <p>When the scale is turned on: Press and hold the switch to turn OFF the scale. Press the switch to ZERO the scale and display zero.</p>
	<p>During measurement: In the function setting mode to set the parameters: Press the switch to change the parameter of the selected item.</p>
	<p>During measurement: Press the switch to choose a unit specified in the setting mode.</p> <p>In the function setting mode to set the parameters: Press the switch to select the function item.</p>
	<p>During measurement: Press the switch to tare the scale and display zero (net weight display).</p> <p>In the function setting mode to set the parameters: Other than at the item "unit": Press the switch to store new parameters and return to the weighing mode.</p> <p>At the item "unit": Press the switch to select active / inactive for the displayed unit.</p>
	<p>When the scale is turned off: Press and hold the ON/OFF switch while pressing and holding the TARE switch to enter the function setting mode. Further to the above, continue to press and hold the TARE switch to restore the function settings to the factory set values.</p>
	<p>When any switches are no response, Press the RESET switch in order to turn off the scale forcibly.</p>
	<p>When the scale is turned on: By pressing the switch, the scale proceeds to the calibration mode.</p>

5. OPERATION

5.1. Basic Weighing Operation

1. Press the **ZERO ON/OFF** switch to turn the power ON. All the symbols except the comparator LEDs are displayed. When the weight value becomes stable, the display turns off for a moment and displays zero (power-on zero) with the weighing unit used last before turning off.
2. Select a weighing unit using the **UNITS** switch.
 - ❑ See "6. SELECTING A WEIGHING UNIT" in detail.
3. When the display doesn't show zero, press the **ZERO ON/OFF** switch to set the display to zero.
4. When using a tare (container), place the container on the weighing pan, and press the **TARE** switch to set the display to zero.
5. Place the object to be weighed on the weighing pan or in the container, and wait for the STABLE indicator to turn on and read the value.
6. Remove the object from the weighing pan.
7. To turn the power off, depress the **ZERO ON/OFF** switch until **OFF** is displayed and the " * " mark illuminates. Then release the switch to turn the power off.

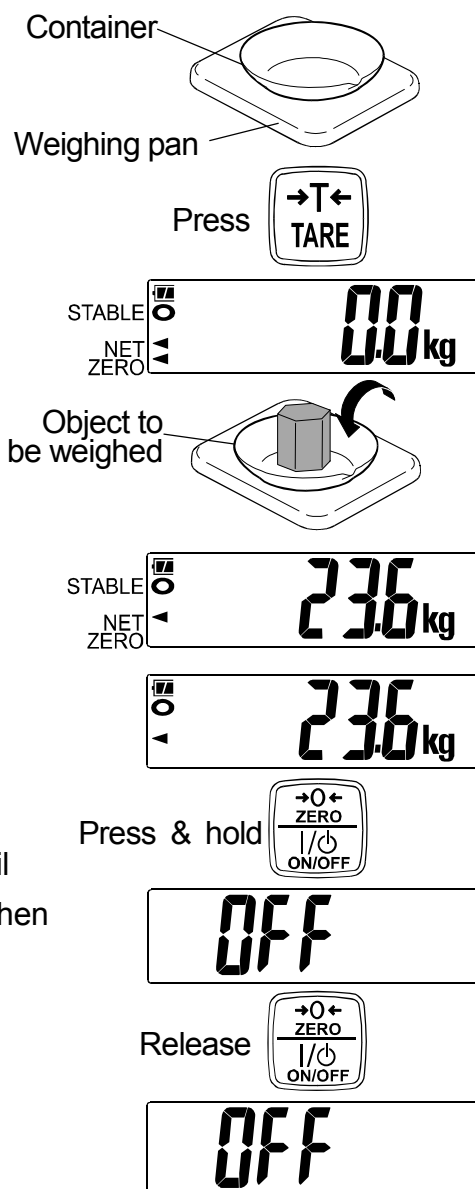

5.2. Notes About Operations

Power-on zero

- ❑ If the weight is unstable at power ON, the scale displays **-----**. Check anything touches the weighing pan, or check if there is strong wind or vibration.
- ❑ The range for power-on zero is within $\pm 50\%$ ($\pm 10\%$ for Legal for Trade models) of the weighing capacity (kg) at the calibrated zero point. If the scale is powered on with a load beyond this range, the scale displays **-----**. Remove the load from the weighing pan.

ZERO and TARE

- ❑ The **ZERO ON/OFF** (as ZERO switch) and **TARE** switches work when the weight value is stable.
- ❑ The **ZERO ON/OFF** switch will zero the scale if the weight value is within $\pm 2\%$ of the weighing capacity (kg) at the power-on zero point. The ZERO ◀ indicator turns on. (ZERO operation)

- ❑ The **TARE** switch will tare the scale and subtract the weight to zero as a tare weight when the weight is a plus value. In this case the ZERO ◀ and NET ◀ indicators turn on. (TARE operation) At the zero point, the net weight display shows the tare weight in negative, and the ZERO ◀ and NET ◀ indicators turn on.
(Note: In some countries or areas, the ZERO ◀ indicator will not turn on while the scale is tared.)
- ❑ When the scale is tared, weighing range for net loads is reduced by the amount of the tare weight.
- ❑ When the ZERO operation is performed in the net weight display, the tare operation previously done is cleared and the NET ◀ indicator turns off.
(Note: In some countries or areas, the ZERO operation will not clear the TARE operation. Press the **TARE** switch after zeroing the scale with nothing on the weighing pan.)

Auto power-off function

- ❑ If no switch is pressed and the stable indicator is displayed for a certain period of time, the scale will automatically turn off. See the function setting **PoFF** to set the elapsed time to turn off.
- ❑ When **E** or **-E** is displayed (refer to "12.2. Error Codes"), the auto power-off function is enabled.

LCD backlight

- ❑ The LCD backlight is controlled by the functions **L-it** and **L-i**.
- ❑ If no switch is pressed and the weight display continues to be stable for a certain period of time, the LCD backlight will automatically turn off. The elapsed time to turn off is set by the function setting **L-it**. The backlight always on or off is also selectable.
- ❑ The function setting **L-i** adjusts the brightness of the backlight.

5.3. Weight Display Resolution

The weight display resolution is a ratio of the minimum display to the weighing capacity. The SJ-WP series has four types of weight display resolution, as shown below.

Low:	1/3,000
Normal:	1/6,000 or 1/7,500 (depending on the weighing capacity)
High:	1/12,000 or 1/15,000 (depending on the weighing capacity)
Maximum:	1/30,000

The factory setting is the normal resolution. Select the resolution according to your own application in the function setting **rE50**.

- ❑ For details about the minimum display and the weighing capacity, refer to "13. SPECIFICATIONS".
- ❑ The weight display resolution of the Legal for Trade models is fixed. The selection in the function setting **rE50** is not available.
- ❑ In the counting mode, the scale works with the maximum resolution regardless of the weight display resolution selected in the function setting **rE50**.

6. SELECTING A WEIGHING UNIT

6.1. Storing The Weighing Unit

1. Press the **ON/OFF** switch while pressing and holding the **TARE** switch in order to display **P-***** in the function setting mode.
2. Press twice the **UNITS** switch to display **PoFF**.
3. Press the **SAMPLE** switch to display a unit. Press the **TARE** switch to activate or deactivate the unit. The indicator **o** is displayed for each active unit.
4. Repeat step 3 for other units.
5. Press the **UNITS** switch to move to the next function item when finishing the selection.
6. Press the **TARE** switch to store new units. The scale returns to the weighing mode.

Unit	Symbol	Conversion to gram
Gram	g	1.00000 g
Kilogram	kg	1000.00 g
Pound (UK)	lb	453.59237 g
Ounce (avoir)	oz	28.349523125 g
Troy ounce	ozt	31.1034768 g
Pound - Ounce	^{oz} lb	—
Tael (Hong Kong general, Singapore)	tl "Unit S"	37.7994 g
Tael (Hong Kong jewelry)	tl "Unit H"	37.4290 g
Tael (Taiwan)	tl "Unit t"	37.5 g
Tola	t	11.6638038 g
Counting unit	pcs	—
Newton	N	See below

Newtons is a value calculated as follows:

$$\text{Newtons} = (\text{value in grams}) \times (9.80665 \text{ m/s}^2) / 1000$$

6.2. Selecting The Weighing Unit

In the weighing mode, press the **UNITS** switch to select a weighing unit.

Each time the **UNITS** switch is pressed, the unit changes as shown below.

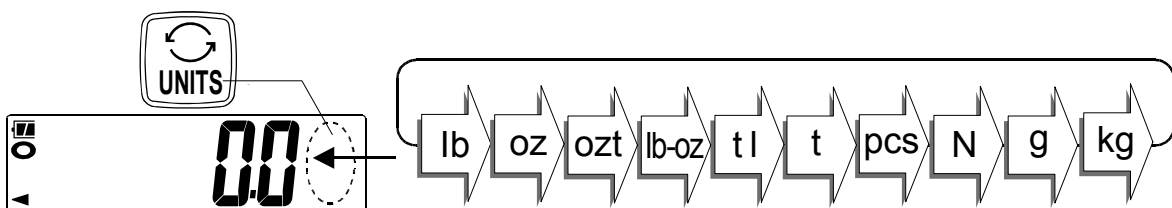

7. COUNTING MODE

Determines a unit weight (the weight of one piece) from a known sample quantity, and calculates how many pieces are on the weighing pan using the unit weight. The unit weight is maintained even if the power is turned OFF.

1. Press the **UNITS** switch to select "pcs". ("pcs" = pieces)

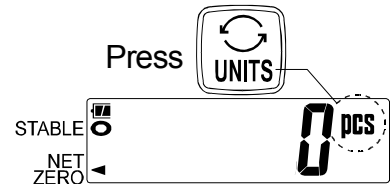

2. Press the **SAMPLE** switch to enter the sample unit weight storing mode. The numerical value on the left indicates the number of samples.

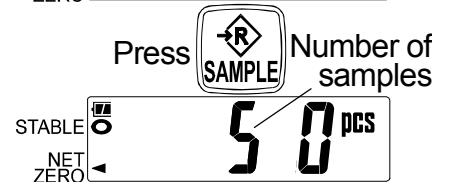

3. Pressing the **SAMPLE** switch allows you to change the number of samples in the order 5 → 10 → 20 → 50 → 100 → ESC → 5.

• By pressing the **UNITS** switch when **ESC** is displayed, the scale exits the sample unit weight storing mode to the count display.

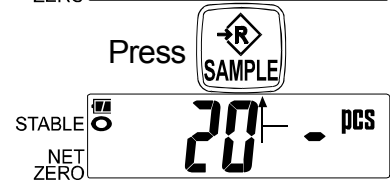

4. When "-" appears at the right side of the number of samples, press the **ZERO ON/OFF** switch to zero the scale. If necessary, place a container on the weighing pan, and press the **TARE** switch. Confirm that the right side of the number of samples shows zero.

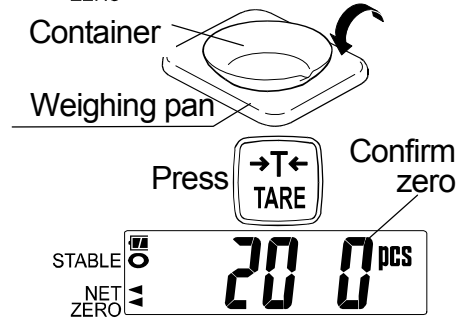

5. Place the correct number of samples on the weighing pan or in the container.

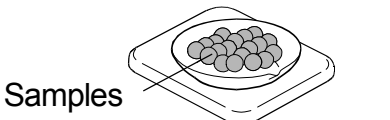

6. Confirm that the STABLE indicator is turned on. Press the **UNITS** switch to calculate and store the unit weight. Remove the samples. The scale is set to count objects with this unit weight.



□ The total weight of samples should be more than shown below, regardless of the number of samples.

SJ-3000WP:	2.5 g
SJ-6000WP:	5 g
SJ-15KWP:	12.5 g
SJ-30KWP:	25 g

If not, the display shows **Lo wt** and returns to the display of step 5. Increase the number of samples (step 3) and try again.

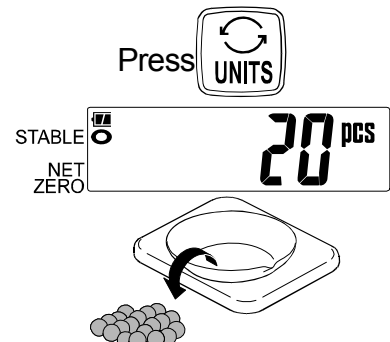

7. Place the objects to be counted on the weighing pan.



8. COMPARATOR

The scale has three-, five- and seven-level comparators.

Each comparator mode compares the weight value against the preset limit values and outputs the results using LEDs (yellow / green / red).

Note: When the unit is "lb-oz" or "t", this function can not be used.

- Five-level comparator mode:
Uses four comparator values to compare the weight value and outputs results in five levels of LOLO, LO, OK, HI and HIHI.

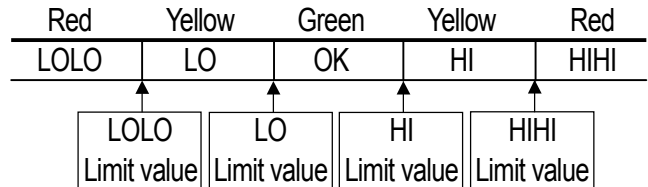

- Three-level comparator mode:
Uses two comparator values (upper and lower limit values) to compare the weight value and outputs results in three levels of LO, OK and HI.

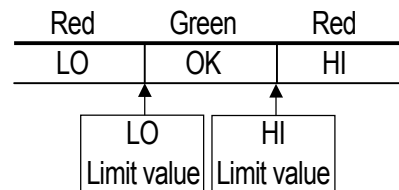

- Seven-level comparator mode (portion weighing mode):
Uses six comparator values to compare the weight value and outputs results in seven levels of outside the lowest limit, level 1 (LOLO), level 2 (LO), Level 3 (OK), level 4 (HI), level 5 (HIHI) and outside the highest limit.

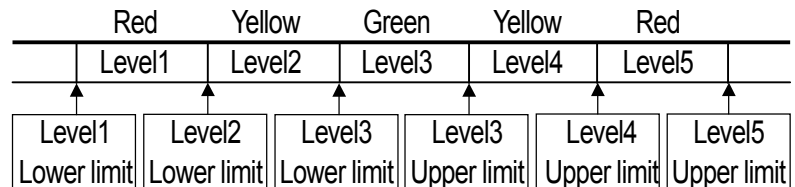

- ❑ To use the comparator modes, the function settings [P-L] and [P] must be specified and the comparator values must be set.
- ❑ Using the function setting [P-L], select a comparator mode.
 - 0: Five-level comparator mode (Result LED blinks)
 - 1: Five-level comparator mode (Result LED lights)
 - 2: Three-level comparator mode (Result LED blinks)
 - 3: Three-level comparator mode (Result LED lights)
 - 4: Seven-level comparator mode (Result LED blinks)
 - 5: Seven-level comparator mode (Result LED lights)
- ❑ Using the function setting [P], select comparison conditions.
 - 0: No comparison (comparator disabled).
 - 1: To compare all data.
 - 2: To compare all stable data.
 - 3: To compare all data which are $\geq +5d$ or $\leq -5d$.
 - 4: To compare stable data which are $\geq +5d$ or $\leq -5d$.
 - 5: To compare all data which are $\geq +5d$.
 - 6: To compare stable data which are $\geq +5d$.





d = minimum display in kg (Refer to "13. SPECIFICATIONS".)

In the counting mode, "d" is equal to the minimum weight display of kg mode.



8.1. The Formula To Compare

Comparison is performed using the formula listed below and the results are output.







Five-level comparator mode

Results	Comparison formula	LED display
LOLO	Displayed value < LOLO limit, $\boxed{-\epsilon}$	 (Red LED on)
LO	LOLO limit \leq Displayed value < LO limit	 (Yellow LED on)
OK	LO limit \leq Displayed value \leq HI limit	 (Green LED on)
HI	HI limit < Displayed value \leq HHI limit	 (Yellow LED on)
HHI	HHI limit < Displayed value, or $\boxed{\epsilon}$	 (Red LED on)

Three-level comparator mode

Results	Comparison formula	LED display
LO	Displayed value < LO limit, or $\boxed{-\epsilon}$	 (Red LED on)
OK	LO limit \leq Displayed value \leq HI limit	 (Green LED on)
HI	HI limit < Displayed value, or $\boxed{\epsilon}$	 (Red LED on)

Seven-level comparator mode (portion weighing mode)

Results	Comparison formula	LED display
None	Displayed value < Level 1 lower limit, or $\boxed{-E}$	 (No LEDs on)
LOLO (Level 1)	Level 1 lower limit \leq Displayed value < Level 2 lower limit	 (Red LED on)
LO (Level 2)	Level 2 lower limit \leq Displayed value < Level 3 lower limit	 (Yellow LED on)
OK (Level 3)	Level 3 lower limit \leq Displayed value \leq Level 3 upper limit	 (Green LED on)
HI (Level 4)	Level 3 upper limit < Displayed value \leq Level 4 upper limit	 (Yellow LED on)
HIHI (Level 5)	Level 4 upper limit < Displayed value \leq Level 5 upper limit	 (Red LED on)
None	Level 5 upper limit < Displayed value, or \boxed{E}	 (No LEDs on)

- The comparator values are common to the weighing and counting mode.
- Ignore the decimal point when setting the comparator values.

Example for SJ-6000WP when the setting value is "001000":

Display mode	Limit value	Capacity / Minimum display
Normal resolution kg	1.000 kg	6.000 kg / 0.001 kg
High resolution kg	0.1000 kg	6.0000 kg / 0.0005 kg
Maximum resolution g	100.0 g	6000.0 g / 0.2 g
Low resolution oz	100.0 oz	210.0 oz / 0.1 oz
Normal resolution oz	10.00 oz	210.00 oz / 0.05 oz
High resolution oz	10.00 oz	210.00 oz / 0.02 oz
Counting mode	1000 pcs	

- The comparator values are maintained even if the power is turned OFF.
- The scale does not judge magnitude relation among the comparator values. Even if the wrong values are set, no error will be shown.

8.2. Entering The Comparator Values

- With the display off, while depressing the **TARE** switch, press the **ON/OFF** switch to display the software version. (e.g. P-1.08)
Press and hold the **UNITS** switch to enter the comparator value setting mode.
- Enter the comparator values using the following switches.
UNITS To shift the blinking digit to the right.
SAMPLE To increase the value of the blinking digit by one.
TARE To store the setting value and to go to the next limit setting or **End**.
 The minus sign can be set at the next digit of the least significant digit.
 The **SAMPLE** switch alternates the minus sign on and off. The blinking "-" shows minus and no sign shows plus.
- When the setting is complete, the scale memorizes the values and displays **End**, then returns to the weighing mode. (At this time, power-on-zero is not performed.)

Five-level comparator mode

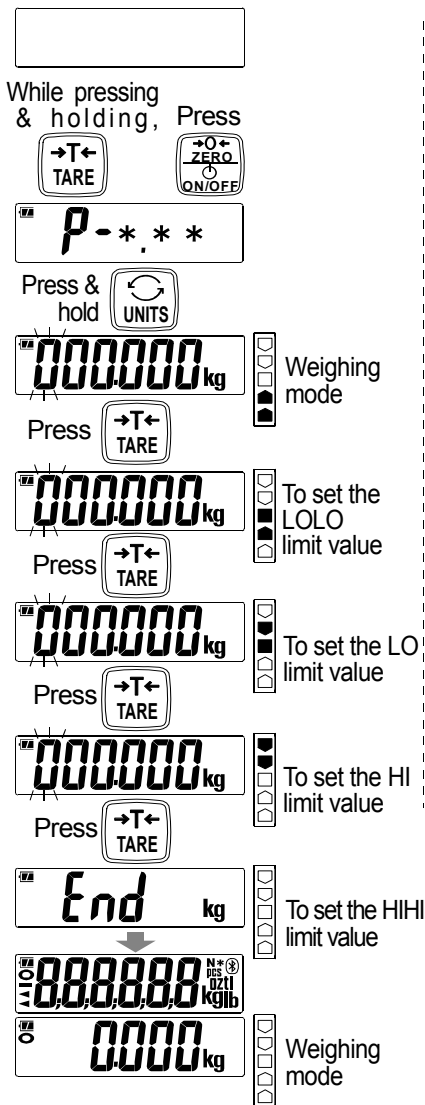

Three-level comparator mode

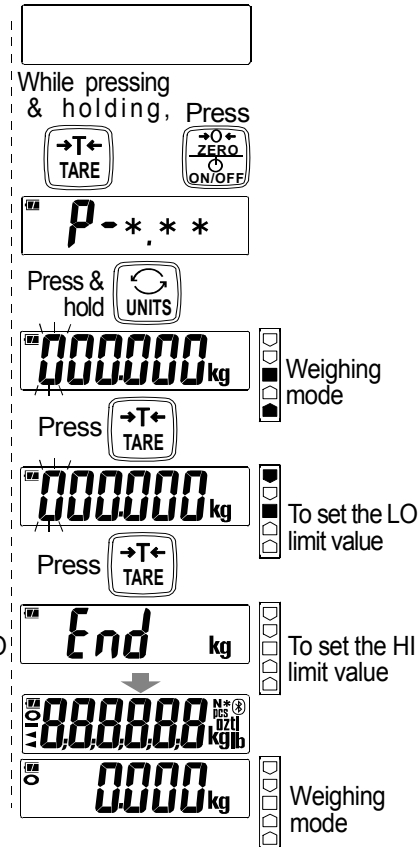

Seven-level comparator mode

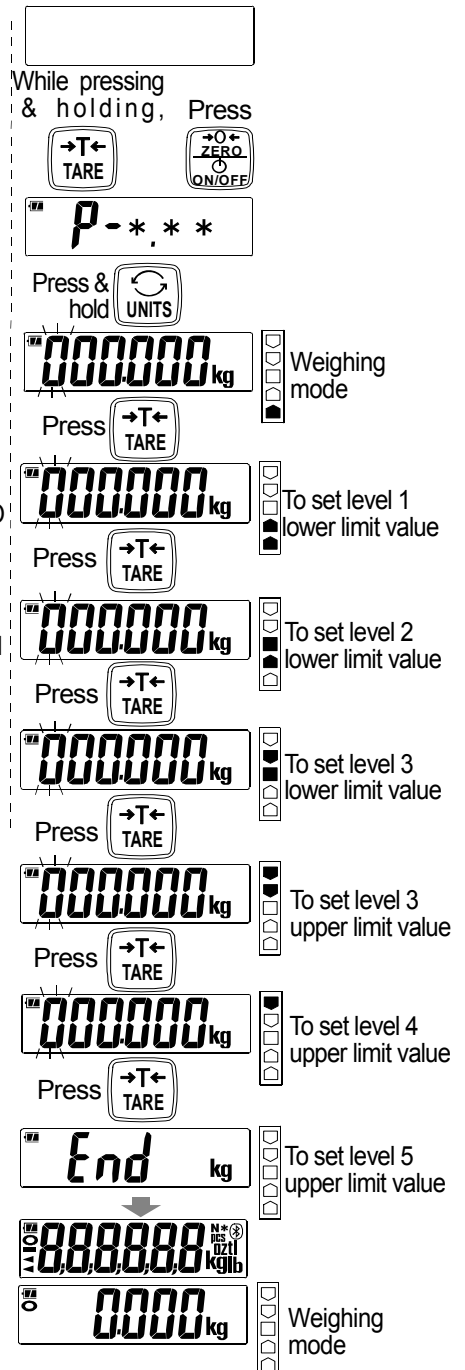

9. AUTO-TARE

The SJ-WP series has an auto-tare function to be used with the comparator mode enabled. If the weight values are in the OK range of comparator limits and stable for a preset period of time, the scale will automatic 1 ally tare the weight and show zero.

- ❑ In some countries or areas, the auto-tare function can not be used on the Legal for Trade models and the selection in the function settings A_t, A_t-t and A_t-F is not available.
- ❑ To use the auto-tare function, set the function settings below.
 - [P 1] : Compare all weighing data (other settings may be used depending on the application).
 - A_t 1 : Auto-tare function enabled.
 - A_t-t 0 to 9 : Select the timing to tare automatically to avoid the wrong tare operation, for example; too early to tare, to take a longer time to go to the next weighing.

Normal comparison [P-P 0]

- ❑ Start with display zero after tare operation. Place or take away objects until the comparison result will show OK. When the stable indicator is ON for a the preset period of time specified in the function setting A_t-t, the scale will automatically tare the weight, show zero and be ready for next weighing to repeat.

Negative comparison for take-away [P-P 1] (example with [P-L 0])

- ❑ Take-away check weighing (negative comparison) is the way to compare the negative weight while taking away objects from a container.

Set the function [P-P 1]

together with the auto-tare

function enabled A_t 1. In this operation mode, the scale operates as "take-away the objects" → "OK and stable" → "auto-tare" → "take-away the objects" → ...

In this setting, the polarity of LOLO, LO, HI, and HIHI limit values are ignored and the scale shows the comparator results as below.

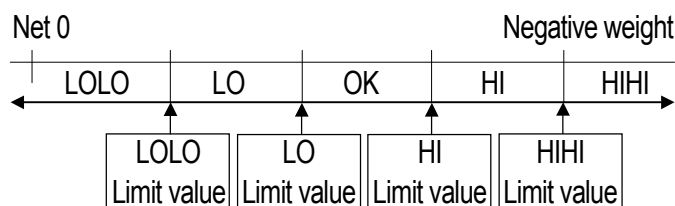

Note: To start the take-away check weighing, be sure to use the TARE switch to tare the weight of the container filled with objects. The ZERO switch may zero the display, and the scale goes below the zero point by taking out the objects. Then, the auto-tare function does not work.

- ❑ When the function "A_t-F 1 Tares the initial (container) weight" is selected: To start the auto-tare function, usually the container (filled with objects) will be placed on the weighing pan and its weight must be tared using the TARE switch. When the function A_t-F 1 is selected, the scale will tare the initial (container) weight automatically. When all load on the weighing pan is removed, the scale will return to the zero point and the tare weight will be automatically cleared. If the scale does not return to the zero point, press the ZERO ON/OFF switch to clear the tare weight.

10. CALIBRATION

Adjusts the scale for accurate weighing. Calibrate the scale in the following cases.

- When the scale is first installed.
- When the scale has been moved.
- When the ambient environment has changed.
- For regular calibration.

Note: The Legal for Trade models can not be re-calibrated if they have been sealed.

10.1. Calibration Mode

- The calibration mode has the following three functions.
 - Gravity acceleration correction
 - Calibration using a weight
 - Restoring the factory set values
- How to enter the calibration mode

Method 1:

1. With the display off, while depressing the **TARE** switch, press the **ON/OFF** switch to display the software version. (e.g. P-1.08)
2. Depress the **SAMPLE** switch for five seconds or longer to switch to the calibration mode.

Note: The above operation is disabled for the Legal for Trade models.

Method 2:

1. Make sure that the scale is in the weighing mode.
2. Loosen the two screws on the switch cover and open the switch cover. The calibration (CAL) switch is located inside.
3. Press the **CAL** switch. The scale displays the gravity acceleration value (in this example, "9.7985").

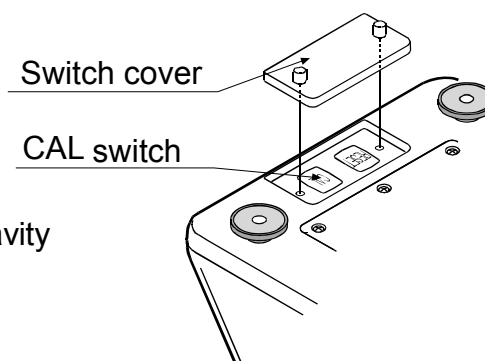

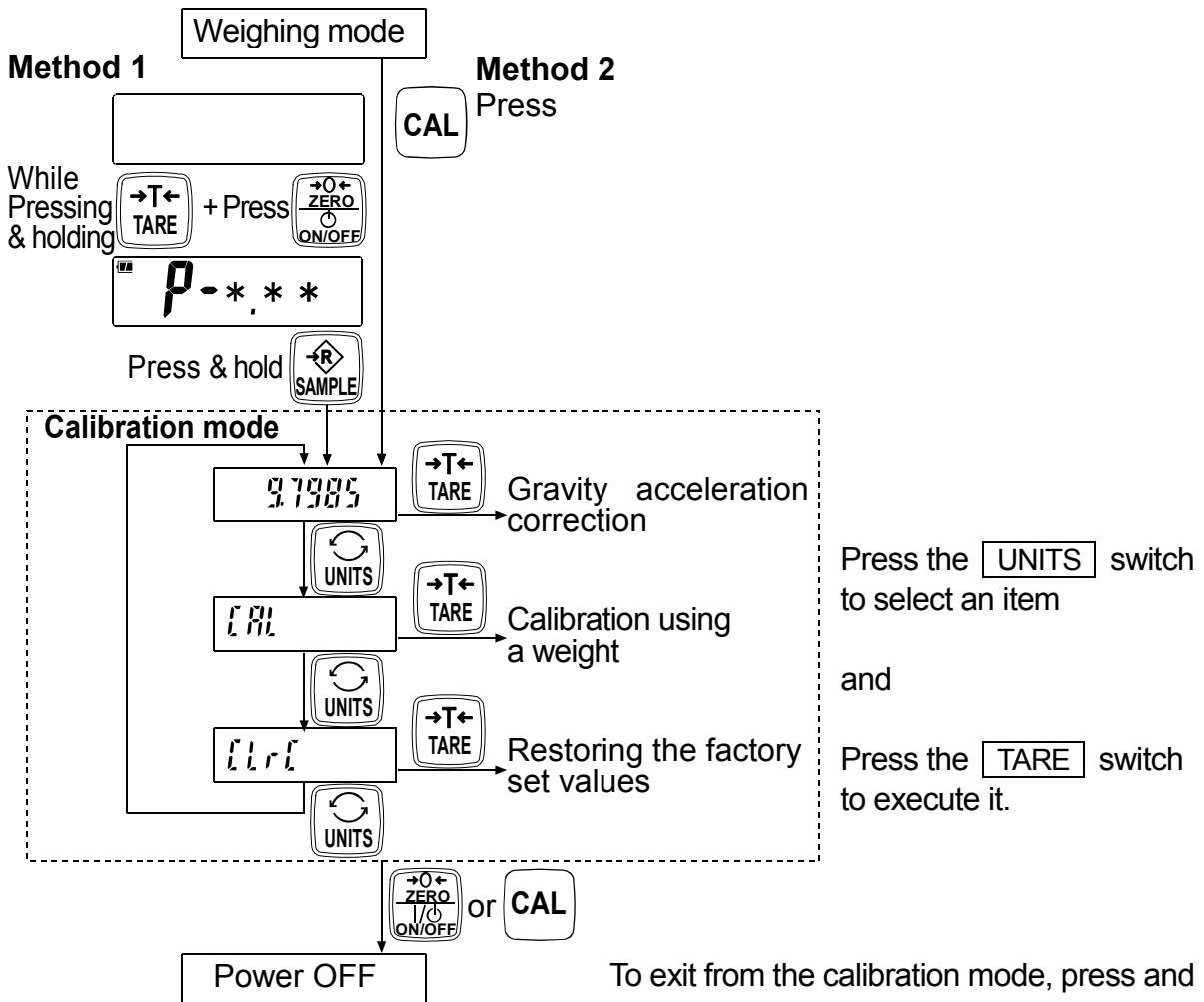

To exit from the calibration mode, press and hold the **ZERO ON/OFF** switch or press the **CAL** switch. The scale turns the power OFF.

10.2. Gravity Acceleration Correction

When the scale is first used or has been moved to another location, it should be calibrated using a calibration weight. But if a calibration weight is not available, the gravity acceleration correction will compensate the scale. Change the gravity acceleration value stored in the scale to the value of the area where the scale will be used. Refer to the gravity acceleration map at the end of this manual.

Note: Gravity acceleration correction is not required when the scale will be calibrated using a calibration weight at the place where it is to be used.

1. Refer to "10.1. Calibration Mode" to enter the calibration mode. The gravity acceleration value is displayed.
2. Press the **TARE** switch to enter the gravity acceleration value setting mode.
3. Change the displayed value using the following switches.
UNITS To shift the blinking digit to the right.
SAMPLE To increase the value of the blinking digit by one.
4. Press the **TARE** switch. The display shows **End** and returns to the newly stored gravity acceleration value.
5. When calibration using a calibration weight is to be performed, go to step 3 of "10.3. Calibration Using A Weight".
To finish the setting procedure, press and hold the **ZERO ON/OFF** switch or the CAL switch. The scale returns to the weighing mode.

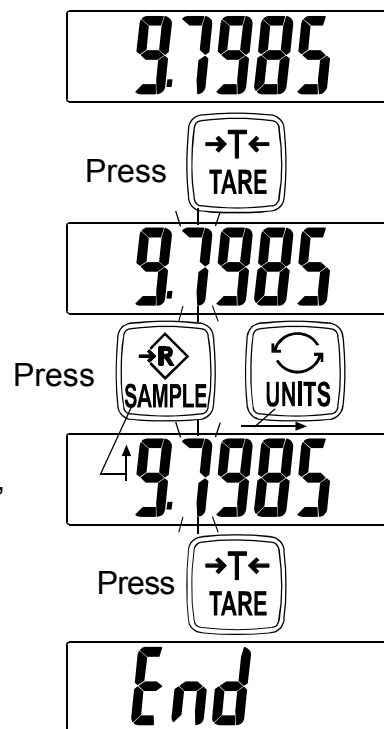

10.3. Calibration Using A Weight

Prepare a weight, preferably a weight with the same value as the weighing capacity of the scale to be calibrated. Note that the calibration weight value can be changed.

1. Turn the power ON and warm up the scale for at least half an hour.
- Change the function setting PoFF or place something on the weighing pan to disable the auto power-off function.
2. Refer to "10.1. Calibration Mode" to enter the calibration mode. The gravity acceleration value is displayed.
3. Press the UNITS switch and the scale displays CAL.
4. Press the TARE switch, then ° CAL 0 is displayed. Confirm that nothing is placed on the weighing pan and wait for the STABLE indicator to turn on.
5. Press the TARE switch. The scale calibrates the zero point and displays the value of the calibration weight (SPAN calibration).
- The calibration weight value is equal to the weighing capacity. (factory setting)
- If SPAN calibration is not to be performed, turn the power OFF to exit from the calibration procedure.
6. To calibrate with a weight different from the weighing capacity, change the displayed value using the following switches.
 - UNITS To shift the digit that is blinking to the right.
 - SAMPLE To increase the value of the blinking digit by one.
- Using a weight with the same value as the weighing capacity is recommended. If other weights are used, use one with a value greater than two-thirds of the capacity.
7. Place the calibration weight with the same value as displayed on the weighing pan, and wait for the STABLE indicator to turn on.
8. Press the TARE switch. The scale calibrates SPAN and End is displayed. Then, the display returns to CAL.
 To finish the procedure, press and hold the ZERO ON/OFF switch or press the CAL switch. The scale turns the power OFF.

9.7985

Press  UNITS

CAL

Press  TARE

° CAL 0 kg

Press  TARE

6.0000 kg

Press  SAMPLE  UNITS

5.0000 kg



° 5.0000 kg

Press  TARE

End

Note: If the scale will be moved to another location, set the gravity acceleration value for the present location first and calibrate the scale using a weight. Then, change the gravity acceleration value for the new location.

10.4. Restoring The Calibration Data To The Factory Set Values

If the gravity acceleration value or calibration data is changed unintentionally, restore those values to the factory set values, as follows.

1. Refer to "10.1. Calibration Mode" to enter the calibration mode. The gravity acceleration value is displayed.
2. Press the **UNITS** switch twice to display **[[r[**.
3. Press the **TARE** switch to display **[[r[no** with "no" blinking.
4. Press the **SAMPLE** switch.
[[r[no changes to **[[r[no** with "no" blinking.
- To cancel the restoring procedure, press the **ZERO ON/OFF** switch. The display returns to step 2.
5. When **[[r[no** is displayed, press the **TARE** switch. The factory set values are restored and **End** is displayed. Then, the display returns to **[[r[**.

To finish the setting procedure, press and hold the **ZERO ON/OFF** switch or press the **CAL** switch. The scale turns the power OFF.

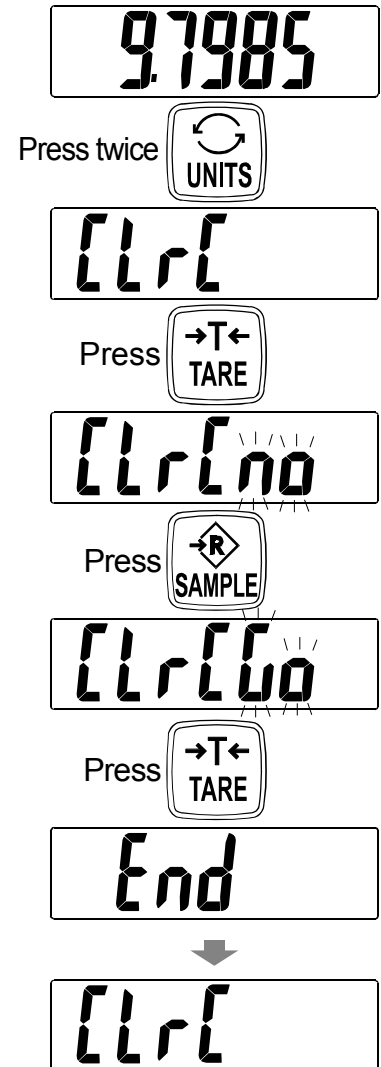

11. FUNCTION SETTINGS

The scale has function settings to specify the scale performance.

The parameters set in the function settings are maintained even if the power is turned OFF.

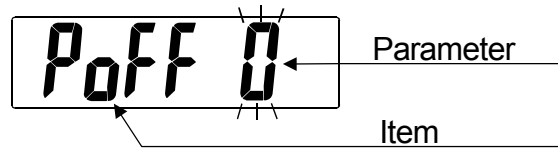

11.1. Setting The Parameters

1. Turn the power OFF.
2. Press and hold the **TARE** switch and press the **ZERO ON/OFF** switch to turn the power ON.
The software version is displayed.
 - ❑ "***" indicates the software version number.
3. Press the **TARE** switch to move to the function setting mode.
4. Change the item or parameter using the following switches.
 - UNITS** To display the next item.
 - SAMPLE** To increase the value of the blinking digit by one (to change the parameter).
- ❑ When the parameter is changed, the STABLE indicator turns off.
5. Press the **TARE** switch to store the setting value.
After displaying **End**, the scale goes to the weighing mode.
 - ❑ To cancel the setting procedure without storing the value, press and hold the **ZERO ON/OFF** switch to turn off the scale.

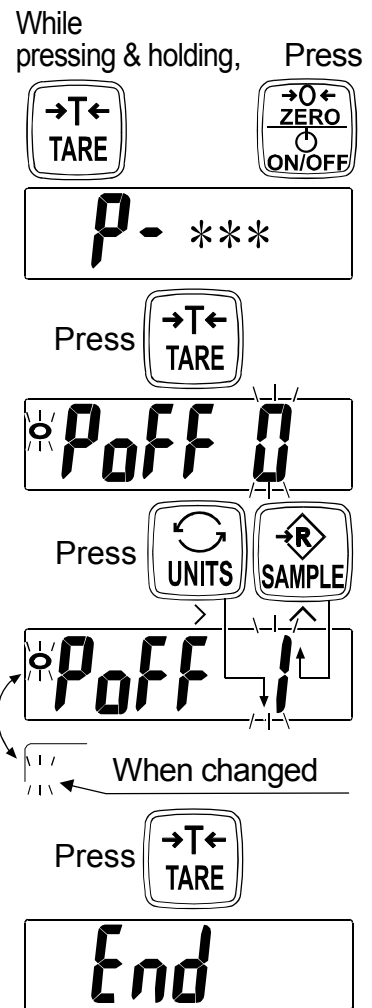

11.2. Restoring The Function Settings To The Factory Set Values

1. Turn the power OFF.
 2. Press and hold the **TARE** switch and press the **ZERO ON/OFF** switch to turn the power ON and to display the software version. Release the **ZERO ON/OFF** switch but continue to press the **TARE** switch until **Lrfno** with "no" blinking is displayed.
 3. Press the **SAMPLE** switch.
Lrfno changes to **Lrfno** with "no" blinking.
 4. When **Lrfno** is displayed, press the **TARE** switch. The factory set values are restored. After displaying **End**, the scale goes to the weighing mode.
- To cancel the restoring procedure, press and hold the **ZERO ON/OFF** switch to turn off the scale.

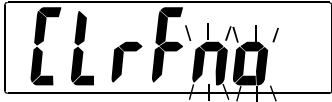

Lrfno

Press 





Lrfno

Press 



End

11.3. Function List

Item	Parameter	Description	
Auto power-off function <i>P_{OFF}</i>	0	Auto power-off function disabled	
	◆ 1	Turns off after 5 minutes	
	2	Turns off after 10 minutes	
	3	Turns off after 15 minutes	
	4	Turns off after 30 minutes	
	5	Turns off after 60 minutes	
Weight display resolution <i>rES₀</i>	0	1/3,000	Changes the minimum display.
	◆ 1	1/6,000 or 1/7,500	
	2	1/15,000 or 1/12,000	
	3	1/30,000	
Weighing unit <i>Unit</i>	SAMPLE	Proceeds to the next unit	Refer to "6. SELECTING A WEIGHING UNIT"
	TARE	Selects whether a unit is active or inactive	
	UNIT	Proceeds to the next setting	
Zero tracking <i>trc</i>	0	Zero tracking function disabled	
	◆ 1	Zero tracking function enabled	
Weighing stability / response speed <i>Cond</i>	0	Weak stability & quick response	
	◆ 1		Response = Time from placing an object on the pan to turning on the stable indicator.
	2		
	3		
	4		
4	Strong stability & slow response		
Backlight control <i>L-it</i>	0	Backlight always off	
	1	Backlight always on	
	◆ 2	Turns off 5 seconds after stabilizing	
	3	Turns off 10 seconds after stabilizing	
	4	Turns off 15 seconds after stabilizing	
	5	Turns off 30 seconds after stabilizing	
Brightness of backlight <i>L-i</i>	0	Dark	Adjusts the brightness of the backlight.
	1		
	◆ 2		
	3		
	4		
Decimal point <i>dP</i>	◆ 0	Dot	
	1	Comma	
Comparator mode <i>CP-L</i>	◆ 0	Five-level (Result LED blinks.)	
	1	Five-level (Result LED lights.)	
	2	Three-level (Result LED blinks.)	
	3	Three-level (Result LED lights.)	
	4	Seven-level (Result LED blinks.)	
	5	Seven-level (Result LED lights.)	

◆ Factory setting

Item	Parameter	Description	
Comparison conditions <i>CP</i>	0	Comparator disabled	
	♦ 1	Compares all data	
	2	Compares all stable data	
	3	Compares all data of $\geq +5d$ or $\leq -5d$	
	4	Compares stable data of $\geq +5d$ or $\leq -5d$	
	5	Compares data of $\geq +5d$	
	6	Compares stable data of $\geq +5d$	
		Sets comparison conditions. d = minimum display in kg.	
Comparator LED brightness <i>CP-1</i>	0		Adjusts LED brightness of comparison result.
	1		
	♦ 2		
	3		
	4		
Normal/Negative comparison <i>CP-P</i>	♦ 0	Normal comparison	
	1	Negative comparison for take-away check weighing	
Auto-tare function <i>At</i>	♦ 0	Auto-tare function disabled	
	1	Auto-tare function enabled	
Auto-tare timing <i>At-t</i>	0	Immediately after OK and stable	
	1	0.5 second after OK and stable	
	♦ 2	1.0 second after OK and stable	
	3	1.5 seconds after OK and stable	
	4	2.0 seconds after OK and stable	
	5	2.5 seconds after OK and stable	
	6	3.0 seconds after OK and stable	
	7	4.0 seconds after OK and stable	
	8	5.0 seconds after OK and stable	
	9	10 seconds after OK and stable	
		Timing to tare automatically after the comparison OK and stable weight.	
Auto-tare of the initial weight <i>At-F</i>	♦ 0	Function disabled	
	1	Tares the initial (container) weight	
		Automatic operation.	
Switch operation <i>EEY</i>	♦ 0	Press and hold switch for 0.5 seconds to enable switch operation	
	1	Press switch and the * mark illuminates. Release switch and press it again within 1 second to enable switch operation.	
	2	Press and hold switch for 1 second until the * mark illuminates. Release switch while the * mark is illuminated (1 second) to enable switch operation	

♦ Factory setting

Switch operation procedure

- When set to **KEY 0**

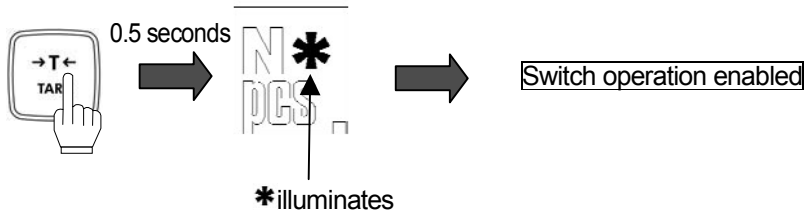

- When set to **KEY 1**
(1) Normal switch operation

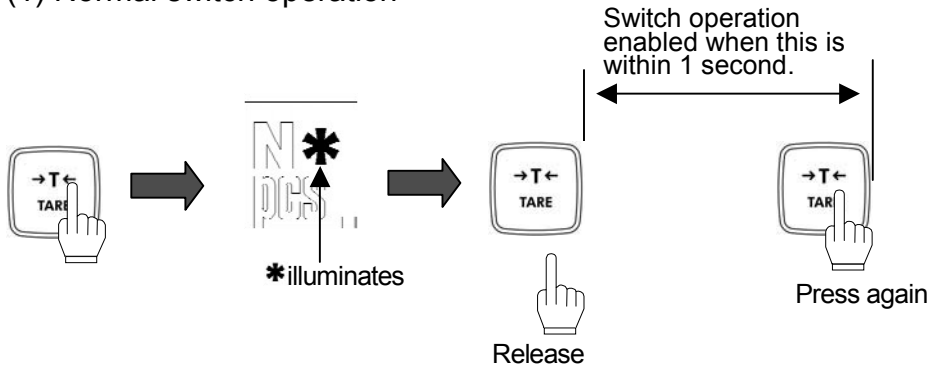

- (2) **ON/OFF** switch operation

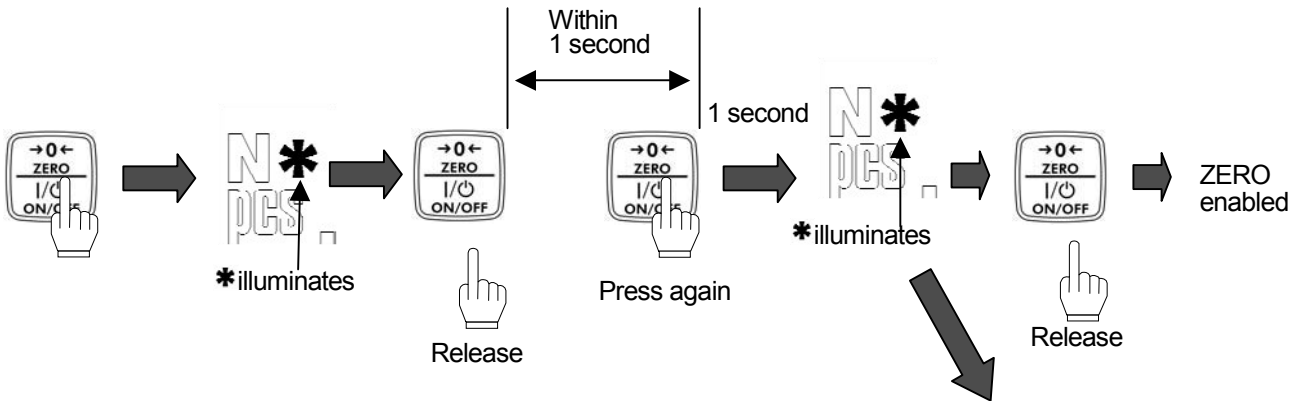

- When set to **KEY 2**
(1) Normal switch operation

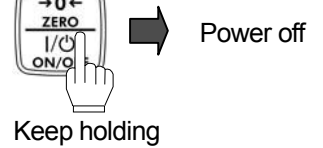
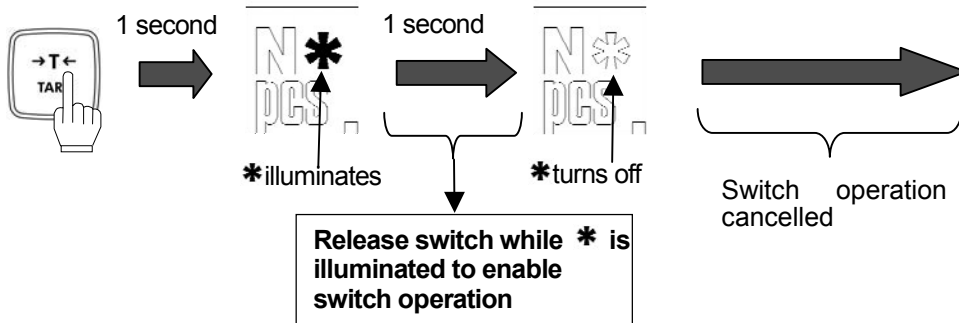

(2) ON/OFF switch operation

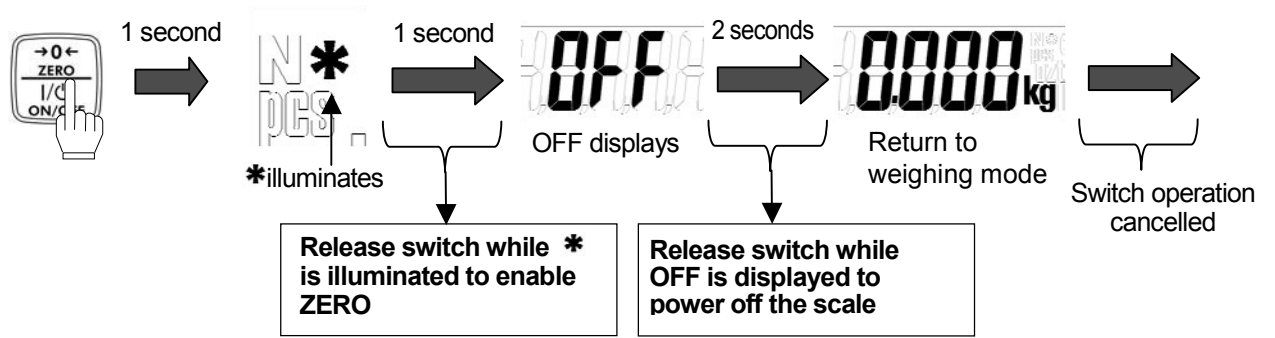

12. MAINTENANCE

12.1. Notes On Maintenance

- ❑ Do not disassemble the scale. Contact your local A&D dealer if the scale needs service or repair.
- ❑ Use the original packaging for transportation.
- ❑ Do not use organic solvents to clean the scale. Use a warm lint free cloth dampened with a mild detergent.
- ❑ Calibrate the scale periodically to maintain the weighing accuracy.

12.2. Pick cleaning

When unable to weigh properly due to dust between the load cell and overload stopper, insert a cleaning pick to remove the dust from the load cell.

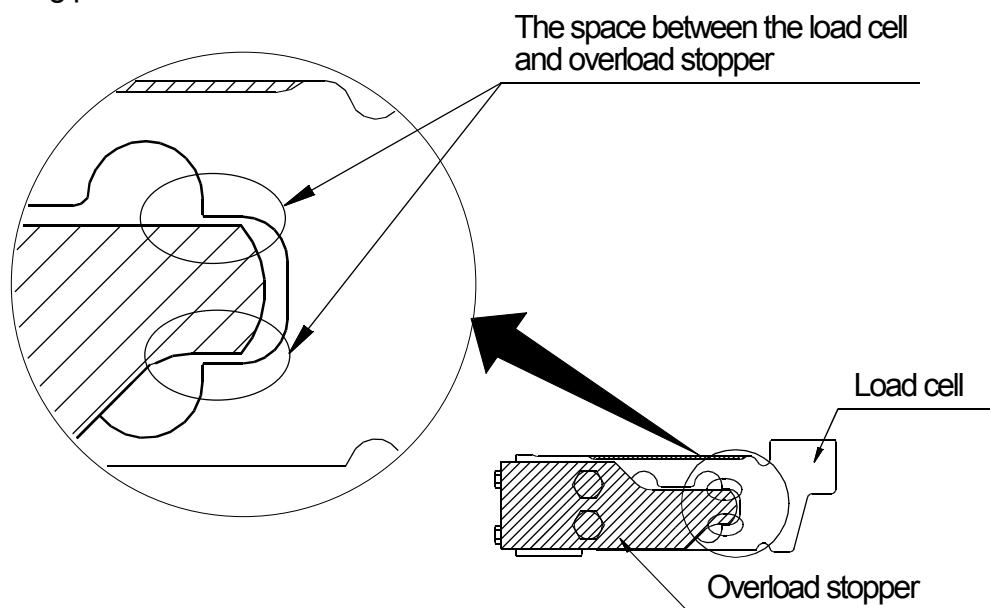

Note:

There are five cleaning picks per sheet.

To use, cut off a cleaning pick when needed.

Use scissors or any bladed object to cut along the perforations to separate a cleaning pick for use.

Exercise extreme caution when using the bladed object to prevent personal injury.

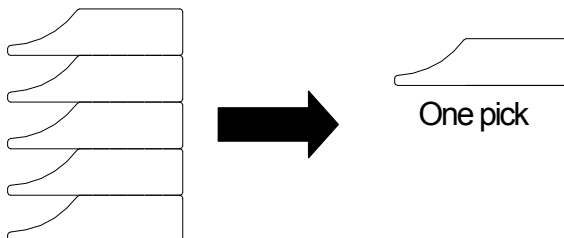

12.3. Error Codes

Overload error



Indicates that an object beyond the weighing capacity has been placed on the weighing pan.
Remove the object from the weighing pan.

Underload error



Indicates that the weight sensor receives a strong upward force. Check if there is anything sandwiched around the weighing pan. There is a possibility that the weight sensor or internal circuit may have a problem.

Power-on zero error

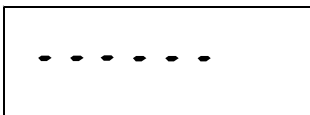

Indicates that the power is turned on with a load beyond the power-on zero range, or the weight value too unstable to perform power-on zero. Remove the load, or check if there is wind, vibration or anything touching the weighing pan.

Unit weight error

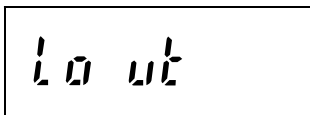

Indicates that total weight of samples is too light to set the unit weight in the counting mode. Increase the number of samples and try again

CAL error

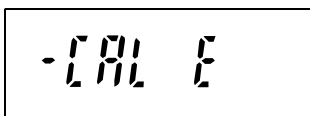

Indicates that the calibration procedure is canceled because the calibration weight is too light.
Check that the weighing pan is installed properly and the mass of the calibration weight is correct.

Low battery

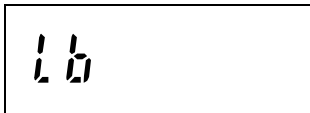

Indicates that the batteries have run out.
Replace them with new batteries.

Other

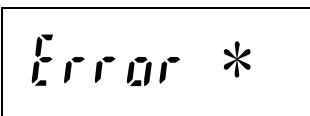

There may be an internal malfunction.
(* indicates an error number.)

Note: If the error persists or other errors occur, contact your local A&D dealer.

13. SPECIFICATIONS

Specifications

Model	SJ-3000WP	SJ-6000WP	SJ-15KWP	SJ-30KWP
Capacity	3 kg	6 kg	15 kg	30 kg
Minimum display "d"	0.001 kg	0.002 kg	0.005 kg	0.01 kg
	0.0005 kg*	0.001 kg*	0.002 kg*	0.005 kg*
	0.0002 kg	0.0005 kg	0.001 kg	0.002 kg
	0.0001 kg	0.0002 kg	0.0005 kg	0.001 kg
Counting	Number of samples: 5, 10, 20, 50 or 100 pieces Maximum count: 120,000			
Repeatability (SD)	0.5 g	1 g	2 g	5 g
Linearity	±1 g	±2 g	±5 g	±10 g
Sensitivity drift	±50 ppm / °C (5 °C to 35 °C / 41 °F to 95 °F)			
Display	Weight display: 7 segment LCD with Backlight, Character height: 26 mm Comparator LEDs: red / yellow / green / yellow / red			
Display update	20 times per second			
Operating temperature	-10 °C to 40 °C / 14 °F to 104 °F, Less than 85 %RH			
Power	6 x R20P / LR20 / "D" size batteries			
Battery life (Approximately)	5000 hours with alkaline cells at 20 °C (LED & Backlight off) 2000 hours with manganese cells at 20 °C (LED & Backlight off)			
Pan size	232 (W) x 192 (D) mm / 9.13 (W) x 7.56 (D) in.			
Dimensions	236 (W) x 260 (D) x 148 (H) mm / 9.3 (W) x 10.2 (D) x 5.8 (H) in.			
Mass	Approximately 4 kg / 9 lb			
Accessories	This manual, Screwdriver, Cleaning pick (One sheet)			
Sold separately	Cleaning pick (Five sheets) AXP-094038331			

* : Factory setting

Unit: mm

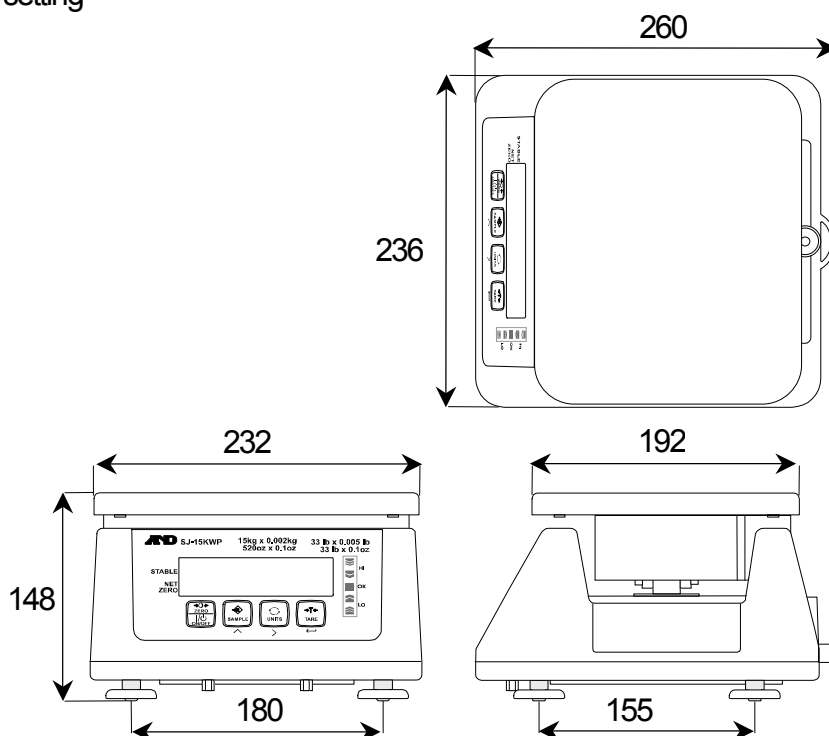

Other weighing units

Model		SJ-3000WP	SJ-6000WP	SJ-15KWP	SJ-30KWP
g	Capacity	3000 g	6000 g	15000 g	30000 g
	Minimum display	1 g	2 g	5 g	10 g
		0.5 g*	1 g*	2 g*	5 g*
		0.2 g	0.5 g	1 g	2 g
		0.1 g	0.2 g	0.5 g	1 g
lb	Capacity	6.6 lb	13 lb	33 lb	66 lb
	Minimum display	0.002 lb	0.005 lb	0.01 lb	0.02 lb
		0.001 lb*	0.002 lb*	0.005 lb*	0.01 lb*
		0.0005 lb	0.001 lb	0.002 lb	0.005 lb
		0.0002 lb	0.0005 lb	0.001 lb	0.002 lb
oz	Capacity	105 oz	210 oz	520 oz	1050 oz
	Minimum display	0.05 oz	0.1 oz	0.2 oz	0.5 oz
		0.02 oz*	0.05 oz*	0.1 oz*	0.2 oz*
		0.01 oz	0.02 oz	0.05 oz	0.1 oz
		0.005 oz	0.01 oz	0.02 oz	0.05 oz
ozt	Capacity	96 ozt	193 ozt	480 ozt	960 ozt
	Minimum display	0.05 ozt	0.1 ozt	0.2 ozt	0.5 ozt
		0.02 ozt*	0.05 ozt*	0.1 ozt*	0.2 ozt*
		0.01 ozt	0.02 ozt	0.05 ozt	0.1 ozt
		0.005 ozt	0.01 ozt	0.02 ozt	0.05 ozt
lb-oz	Capacity	6 lb 9 oz	13 lb	33 lb	66 lb
	Minimum display	0.1 oz	0.1 oz	0.1 oz	0.1 oz
Catty-tl (<i>HG</i>)**	Capacity	4 c 15 tl	9 c 14 tl	24c 12tl	49 c 9 tl
	Minimum display	0.01 tl	0.1 tl	0.1 tl	0.1 tl
Catty-tl (<i>HJ</i>)**	Capacity	5 c	10 c	25 c	50 c
	Minimum display	0.01 tl	0.1 tl	0.1 tl	0.1 tl
Catty-tl (<i>T</i>)**	Capacity	5 c	10 c	25 c	50 c
	Minimum display	0.01 tl	0.1 tl	0.1 tl	0.1 tl
Tola	Capacity	257 t	510 t	1280 t	2570 t
	Minimum display	0.1 t	0.2 t	0.5 t	1 t
		0.05 t*	0.1 t*	0.2 t*	0.5 t*
		0.02 t	0.05 t	0.1 t	0.2 t
		0.01 t	0.02 t	0.05 t	0.1 t

* : Factory setting

** : Catty-tael, *HG* : Hong Kong General / Singapore, *HJ* : Hong Kong Jewelry, *T* : Taiwan

SJ-WP Series Class III Model Specifications

MODEL	SJ-3000WP	SJ-6000WP	SJ-15KWP	SJ-30KWP
Accuracy class	III			
Maximum Capacity	3000 g	6000 g	15 kg	30 kg
Verification scale interval	0.5 g(0~1500 g) 1 g(1500~3000 g)	1 g(0~3000 g) 2 g(3000~6000 g)	2 g(0~6 kg) 5 g(6~15 kg)	5 g(0~15 kg) 10 g(15~30 kg)
Minimum capacity	10 g	20 g	40 g	100 g
Maximum tare	3000 g	6000 g	15 kg	30 kg
Operating temp.	-10°C~40°C (No condensation)			
Display	Weight display: 7 segment liquid crystal display with White Backlight Character height: 26mm Comparator LEDs: red / yellow / green / yellow / red			
Display update	Approximately 20 times per second			
Power	6 x R20P / LR20 / "D" size batteries			
Battery life	Approximately 5000 hours with alkaline cells at 20°C (LED & Backlight off) Approximately 2000 hours with manganese cells at 20°C (LED & Backlight off)			
Platform size	232 (W) x 192 (D) mm			
Dimensions	236 (W) x 260 (D) x 148 (H) mm			
Weight	Approximately 4 kg			
Calibration weight	3000 g ± 0.1 g	6000 g ± 0.2 g	15 kg ± 0.5 g	30 kg ± 1 g

Note:

- The range for power-on zero is within ± 10% of the weighing capacity at the calibrated zero point.
- The weighing units "g", "kg" and "pcs" are available.
- The selection in the function settings rESa, AL, AL-t, and AL-F is not available.

Power-on:

Turning the power on, the scale will be automatically set to zero.

If the power is switched on with a load within +/- 10 % of the weighing capacity at the calibrated zero point (power-on zero range), the scale is zeroed and the ZERO indicator turns on.

If the load is beyond the power-on zero range, the scale is tared and the ZERO and the NET indicators turn on.

Error Message:

- E : Indicates that the gross value (weight value with no tare operation) is less than -19d. If the STABLE indicator is ON, press the ZERO
ON/OFF switch to ZERO the scale. If the STABLE indicator is OFF, turn the power off and on again.
- If these instructions do not work, there is a possibility that the weight sensor or internal circuit may have a problem.

14. GRAVITY ACCELERATION

Values of gravity at various locations

Amsterdam	9.813 m/s ²	Manila	9.784 m/s ²
Athens	9.807 m/s ²	Melbourne	9.800 m/s ²
Auckland NZ	9.799 m/s ²	Mexico City	9.779 m/s ²
Bangkok	9.783 m/s ²	Milan	9.806 m/s ²
Birmingham	9.813 m/s ²	New York	9.802 m/s ²
Brussels	9.811 m/s ²	Oslo	9.819 m/s ²
Buenos Aires	9.797 m/s ²	Ottawa	9.806 m/s ²
Calcutta	9.788 m/s ²	Paris	9.809 m/s ²
Cape Town	9.796 m/s ²	Rio de Janeiro	9.788 m/s ²
Chicago	9.803 m/s ²	Rome	9.803 m/s ²
Copenhagen	9.815 m/s ²	San Francisco	9.800 m/s ²
Cyprus	9.797 m/s ²	Singapore	9.781 m/s ²
Djakarta	9.781 m/s ²	Stockholm	9.818 m/s ²
Frankfurt	9.810 m/s ²	Sydney	9.797 m/s ²
Glasgow	9.816 m/s ²	Taichung	9.789 m/s ²
Havana	9.788 m/s ²	Tainan	9.788 m/s ²
Helsinki	9.819 m/s ²	Taipei	9.790 m/s ²
Kuwait	9.793 m/s ²	Tokyo	9.798 m/s ²
Lisbon	9.801 m/s ²	Vancouver, BC	9.809 m/s ²
London (Greenwich)	9.812 m/s ²	Washington DC	9.801 m/s ²
Los Angeles	9.796 m/s ²	Wellington NZ	9.803 m/s ²
Madrid	9.800 m/s ²	Zurich	9.807 m/s ²

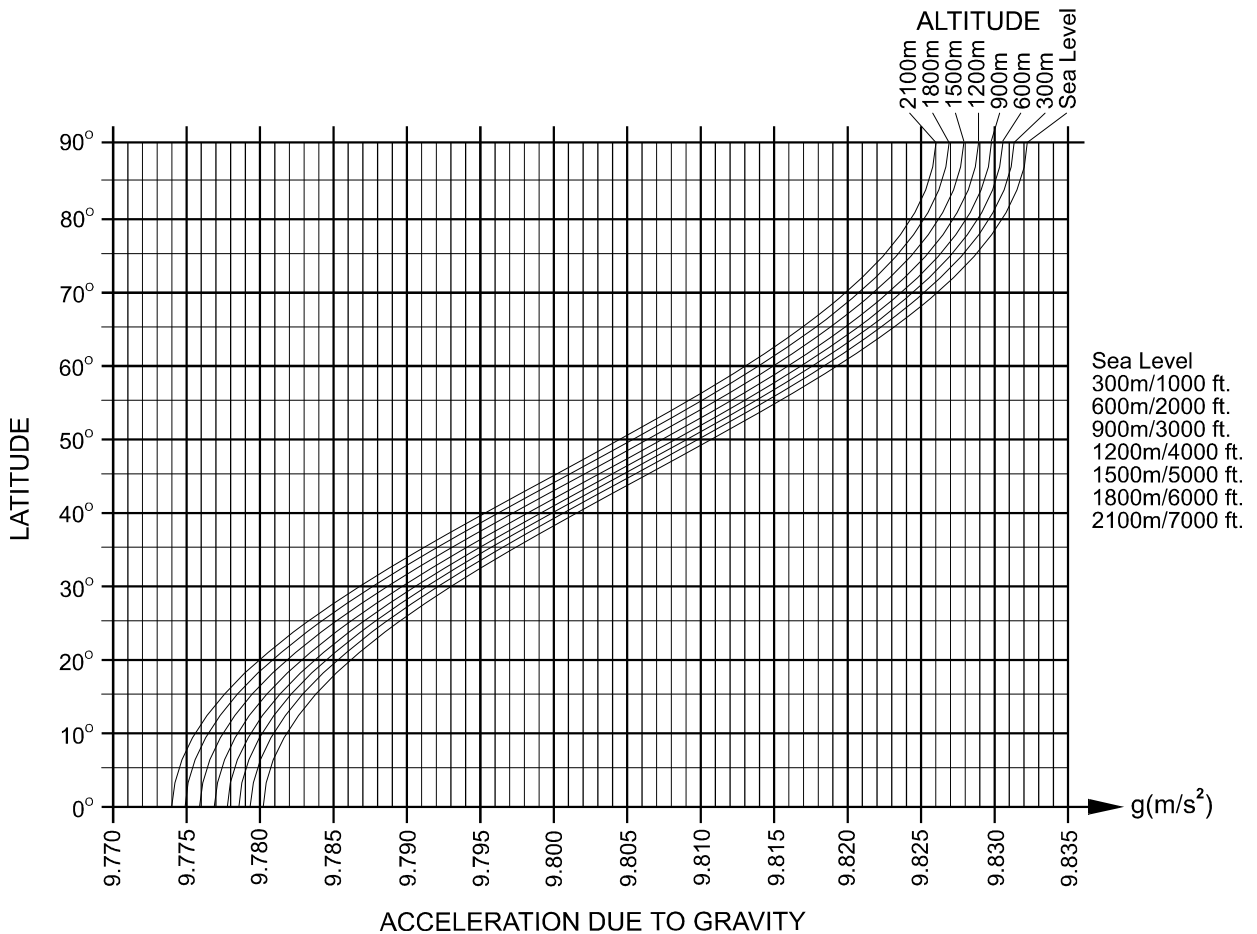

World map

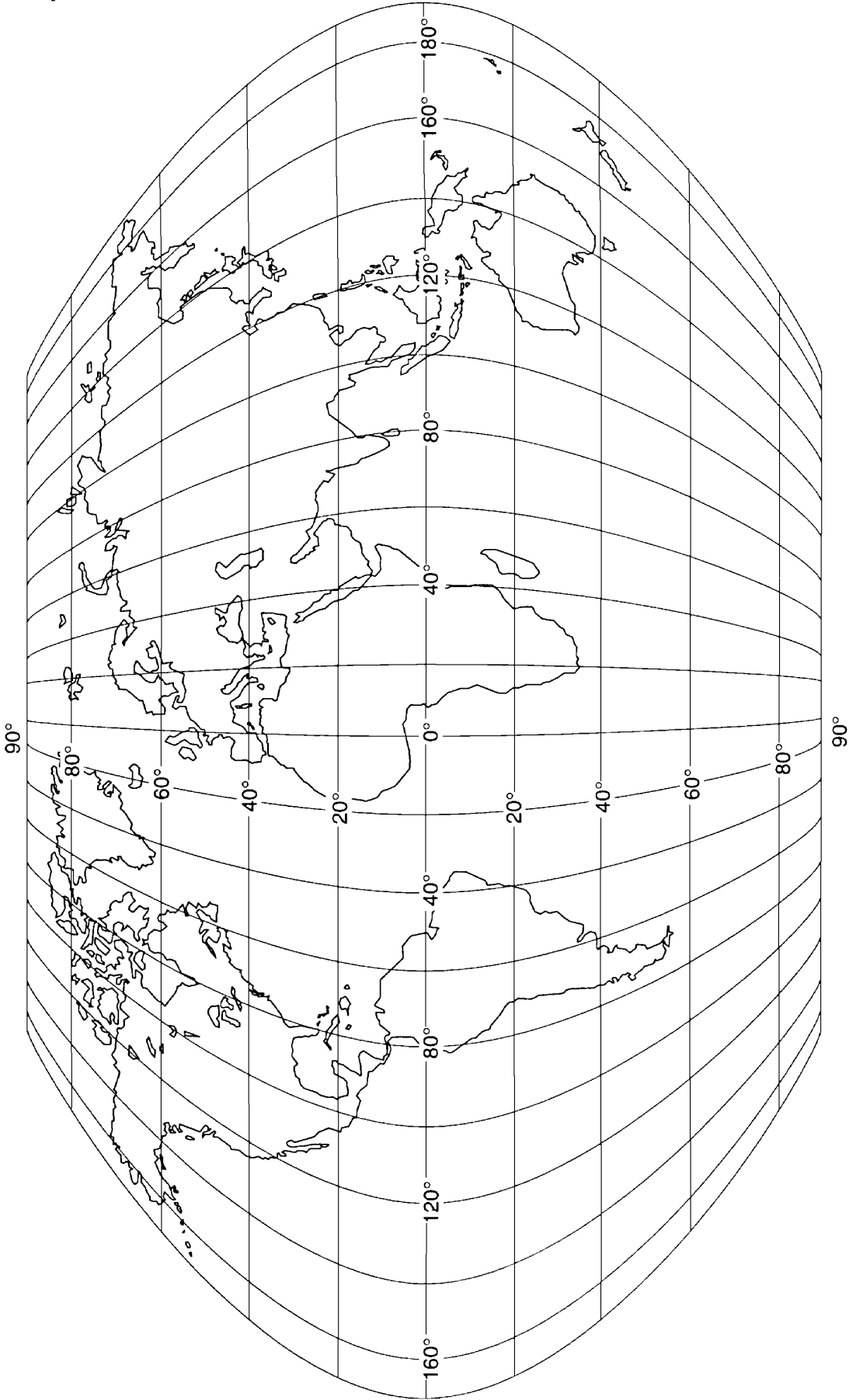



A&D Company, Limited

3-23-14 Higashi-Ikebukuro, Toshima-ku, Tokyo 170-0013, JAPAN
Telephone: [81] (3) 5391-6132 Fax: [81] (3) 5391-6148

A&D ENGINEERING, INC.

1756 Automation Parkway, San Jose, California 95131, U.S.A.
Telephone: [1] (408) 263-5333 Fax: [1] (408)263-0119

A&D INSTRUMENTS LIMITED

Unit 24/26 Blacklands Way, Abingdon Business Park, Abingdon, Oxfordshire OX14 1DY United Kingdom
Telephone: [44] (1235) 550420 Fax: [44] (1235) 550485

A&D AUSTRALASIA PTY LTD

32 Dew Street, Thebarton, South Australia 5031, AUSTRALIA
Telephone: [61] (8) 8301-8100 Fax: [61] (8) 8352-7409

A&D KOREA Limited

한국에이.엔.디(주)
서울특별시 영등포구 국제금융로6길33 (여의도동) 맨하탄빌딩 817 우편 번호 150-749
(817, Manhattan Bldg., 33. Gukjegeumyung-ro 6-gil, Yeongdeungpo-gu, Seoul, 150-749 Korea)
전화: [82] (2) 780-4101 팩스: [82] (2) 782-4280

ООО A&D RUS

ООО "ЭЙ энд ДИ РУС"
121357, Российская Федерация, г.Москва, ул. Вереysкая, дом 17
(Business-Center "Vereyskaya Plaza-2" 121357, Russian Federation, Moscow, Vereyskaya Street 17)
тел.: [7] (495) 937-33-44 факс: [7] (495) 937-55-66

A&D INSTRUMENTS INDIA PRIVATE LIMITED

509, उद्योग विहार, फेस -5, गुडगांव - 122016, हरियाणा, भारत
(509, Udyog Vihar, Phase-V, Gurgaon - 122 016, Haryana, India)
फोन : 91-124-4715555 फैक्स : 91-124-4715599

ऐ&डी इन्स्ट्रुमेन्ट्स इण्डिया प्रा० लिमिटेड